

MANUAL

Electronic circuit breaker
BASIC FIX



TABLE OF CONTENTS

| | |
|------------------------------------------------------------------------------------------|-----------|
| 1 ... ORDERING DATA..... | 3 |
| 2 .. ALLGEMEINE HINWEISE | 4 |
| 2.1 Safety instructions | 4 |
| 2.2 Qualified personnel | 4 |
| 2.3 Intended use | 4 |
| 2.4 Disclaimer..... | 4 |
| 2.5 Installation | 4 |
| 3. .. Product description | 6 |
| 4. .. Tripping characteristic..... | 7 |
| 4.1 Selective immediate switch-off in the event of undervoltage | 7 |
| 4.2 Charging capacitvie loads | 7 |
| 5. .. Operating states, signalling, reactions | 8 |
| 5.1 Switch-on delays for individual channels | 8 |
| 5.2 Button „ON/OFF and RESET“ | 8 |
| 5.3 Signalling and control contacts S1/S2/S3..... | 9 |
| 5.4 Functionality of 2-wire communication via S1/S2..... | 9 |
| Diagnostic options via S1/S2: | 9 |
| 5.5 Details of signal input S1 (ON/OFF/RESET)..... | 11 |
| 5.6 Two-wire interface | 11 |
| 5.7 Details on signal output S2 (status of the outputs)..... | 14 |
| 5.8 Details on signal output S3 (Σ for triggered outputs and device fault) | 15 |
| 6. .. Functional diagram..... | 15 |
| 7.... Dimensions | 16 |

1. ORDERING DATA

Die nachfolgende Tabelle zeigt die Bestelldaten der Lade- und Kontrolleinheit und der Batteriemodule.

Table 1: Ordering numbers

| Variant | Input voltage | Output current | Channels |
|----------------------|---------------|-----------------|----------|
| PM-9824-152-0 | 24 Vdc | 3,8 A | 4 |
| PM-2824-240-0 | 24 Vdc | 6 A | 4 |
| PM-2824-180-0 | 24 Vdc | 2 x 3A & 2 x 6A | 4 |
| PM-9824-076-0 | 24 Vdc | 3,8 A | 2 |
| PM-2824-120-0 | 24 Vdc | 6 A | 2 |

2. ALLGEMEINE HINWEISE

2.1 Safety instructions

Please read these warnings and safety instructions carefully before operating the appliance. The appliance may only be installed by specialised and qualified personnel. In the event of malfunctions or damage, switch off the supply voltage immediately and send the device to BLOCK Transformatoren-Elektronik GmbH for inspection. The device does not contain any service parts. If an internal fuse blows, there is most probably an internal defect in the appliance. The data provided are for product description purposes only and are not to be regarded as warranted characteristics in the legal sense.

2.2 Qualified personnel

The product associated with this documentation may only be handled by qualified personnel in compliance with the documentation associated with the respective task, in particular the safety instructions and warnings contained therein. Qualified personnel can ensure, based on their training and experience, that the use of the described product fulfils all safety requirements as well as the applicable provisions, regulations, standards and laws.

2.3 Intended use

This device is designed for installation in a housing and is suitable for use in general electronic devices, such as industrial control systems, office equipment, communication devices or measuring devices. Do not use this device in the control systems of aeroplanes, trains or nuclear facilities where a malfunction could result in serious injury or danger to life.

2.4 Disclaimer

The contents of this publication have been checked with the utmost care to ensure that they correspond to the hardware and software described. Nevertheless, there may be discrepancies between the product and the documentation. Deviations may also occur due to the continuous further development of the product.

For this reason, we cannot guarantee complete conformity. Should this documentation contain errors, we reserve the right to make any necessary corrections without prior notice.

2.5 Installation

Installation must be carried out in accordance with local conditions, relevant regulations, national accident prevention regulations and the recognised rules of technology. This electrical equipment is a component intended for installation in electrical systems or machines and fulfils the requirements of the Low Voltage Directive (2014/35/EU). The required minimum distance to neighbouring parts must be maintained in order not to impede cooling!



ATTENTION

Switch off the input voltage before carrying out installation, maintenance or modification work and secure it against unintentional switching on again.



ATTENTION

Do not make any changes or attempts to repair the appliance. Do not open the device!



ATTENTION

Prevent the ingress of foreign objects such as paper clips and metal parts.



ATTENTION

Do not operate the appliance in a damp environment or in an environment where condensation or condensation is to be expected.



ATTENTION

Do not touch the housing during operation or shortly after switching off.
Hot surfaces can cause injuries.

3. Product description

If circuits are planned with the same fuse values in many applications, the BASIC FIX circuit breakers form the most economical basis. Different rated current combinations enable a wide range of applications. Each channel includes active current limitation to 1.3 times the preset rated current. In the NEC Class 2 version, the output power is safely limited to less than 100W. The electronic circuit breaker divides the load current into several branches and reliably monitors them for overload and short circuit. The electronics allow short-term current peaks, e.g. due to a high inrush current, while branches with longer overloads are de-energised. The tripping current is fixed for each output. The outputs are switched on with a time delay and load-dependent in order to reduce peak inrush currents. If a circuit is overloaded, only the faulty current path is reliably disconnected thanks to active current limiting without repercussions on the other circuits and can be switched on again after a short waiting time (thermal relaxation) using a push-button or signal contact. A voltage dip on unaffected circuits is reliably prevented. The push-button is also used to switch off the respective output manually. Signal contacts can be used to read out information relevant to operation and to switch individual outputs on or off. The status of the respective output is displayed via a multi-coloured LED.

- Number of available output channels: 2 / 4
- Fixed rated current per channel
- Reliable switching on of high capacitive loads
- Sequential and load-dependent switching of the channels
- Status enquiry and remote switching of the outputs via 2 lines
- Sum signalling contact for simple remote diagnostics
- Remote transmission of the input voltage
- Push-in direct or plug-in connection technology
- LED signalling and on/off/reset button per channel

4. Tripping characteristic

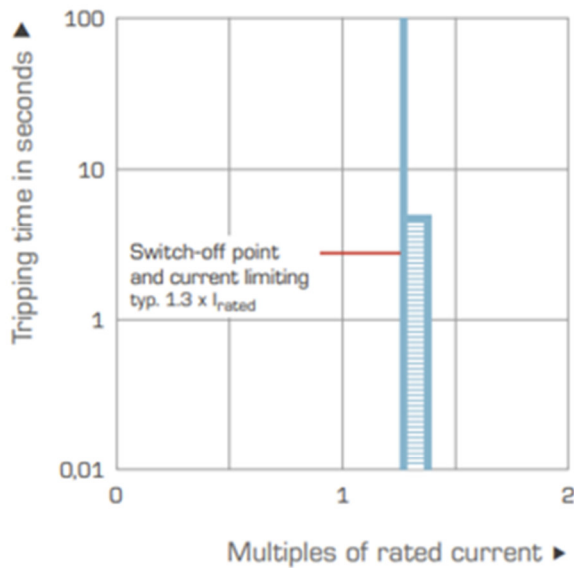

Tripping characteristic PM-2824-xxx-x

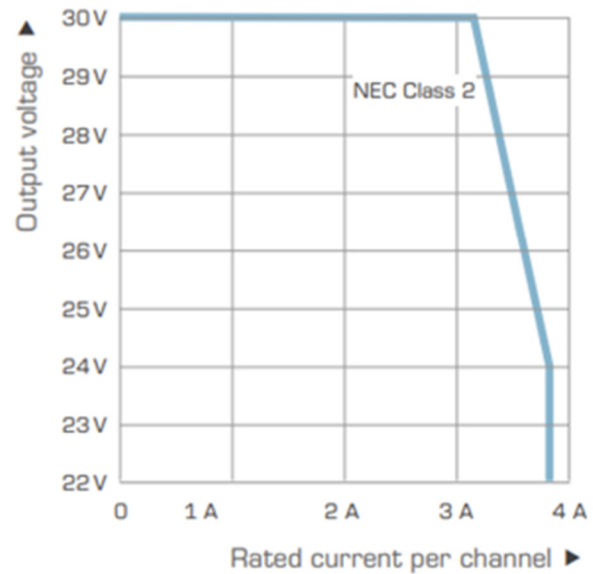

Tripping characteristic PM-9824-xxx-x

The electronic circuit breaker actively limits the overcurrent of each output channel to typically 1.3 times the rated current and is particularly suitable for sensitive loads. The switch-off time varies between 50 ms and 5 s depending on the level of overcurrent. In the event of an overcurrent, only the faulty circuit is selectively switched off. A voltage dip in unaffected circuits is reliably prevented. The NEC Class 2 variant PM-9824 limits the output current to values below 100W at all times and is therefore suitable for the construction of UL Class 2 circuits. Circuits that meet the requirements of Class 2 significantly simplify system approval with UL because no UL-listed components need to be used downstream.

4.1 Selective immediate switch-off in the event of undervoltage

If the power supply unit output voltage falls below 20 V, all outputs that carry more than 100 % of the individually set tripping current at this moment are selectively switched off immediately (max. 16 ms).

4.2 Charging capacitvie loads

The electronic circuit breaker enables particularly high capacitive loads to be switched on.

Minimum capacitance: 70mF @24 Vdc for NEC Class 2 channels with 3.8 A rated current

Minimum capacitance: 58mF @24 Vdc for channels with max. 6 A rated current

Minimum capacitance: 130mF @24 Vdc for channels with max. 1.2A rated current

The capacitance was determined experimentally in each case at nominal current, with a cable length of 2.5 m and a cable cross-section of 2.5 mm².

5. Operating states, signalling, reactions

| Z | Operating status | Output | LED | Signal output S3 (Sum signal) | Button is pressed | Signal input S1 (On/Off/Reset) |
|---|------------------------------------------------------------------------------|--------|-------------------|-------------------------------|----------------------|-------------------------------------------------|
| 0 | Module initialisation | Off | Off | 0V | --- | --- |
| 1 | Output switched on Function OK | On | Green | 24V | Switch off output Z2 | Via bit pattern → Switch off output Z2 |
| 2 | Output is switched off manually or via signal input S1 | Off | Red | 24V | Switch on output Z1 | Via bit pattern → Switch on output Z1 |
| 3 | Output is switched off due to excess current Thermal expansion active | Off | Red Flashing | 0V | --- Z3 | --- Z3 |
| 4 | Output is switched off due to overcurrent Thermal expansion has ended | Off | Orange Flashing | 0V | Switch on output | Long 24V pulse (>0,5 s) → Switch on input Z1 |
| 5 | Device error (defective fuse detected) | Off | Red Fast flashing | 0V | --- Z5 | --- Z5 |

- 1) Once module initialisation is complete, the outputs are switched on depending on the load.
- 2) The status is saved when the device is switched off.
- 3) After a waiting time (thermal expansion), transition to operating state Z4. When the appliance is switched off, the remaining waiting time is saved and waited for when it is switched on again. This reliably prevents overloading of the switching elements even if the appliance is switched on again immediately.
- 4) The affected output can be switched on again by pressing the button twice or via a pulse (>0.5s) at signal input S1, transition to operating state Z1.

5.1 Switch-on delays for individual channels

The outputs are switched on sequentially after a minimum input voltage (switch-on threshold) is reached. To reduce inrush current peaks, all channels are switched on depending on the load.

The channels are switched on starting with the smallest channel number to be switched on, typically starting with channel 1. The next channel is switched on as soon as the output current of the previous channel is below the set nominal value or the previous output has been switched off, but not before 50 ms.

5.2 Button „ON/OFF and RESET“

A button is assigned to each output channel. The current status is displayed via an integrated LED. The button has two functions depending on the operating status:

- Normal operation
If the channel is switched off (button lights up permanently red), it can be switched on by briefly pressing it (button lights up green). Pressing it again switches the output off again.
- Faulty operation
If the output channel is switched off due to an overcurrent (button flashes red), it can be switched on again (reset).

NOTES:

To switch the output back on, the thermal expansion must first be completed (button flashes yellow instead of red). After pressing the button, the output is initially switched off (button lights up red continuously). Pressing the button again switches the output on again. (button lights up green continuously).

The outputs are switched on in the delivery state.

5.3 Signalling and control contacts S1/S2/S3



The electronic circuit breaker is equipped with three signalling and control contacts.

Signal contacts S1 (digital input) and S2 (digital output) can be used to read out operationally relevant information from the circuit breaker and to switch any output channels on or off.

A sum reset (switching back on) of all triggered outputs (outputs not switched off manually) is also possible via signal input S1, provided a 24V high pulse is fed in for at least 0.5 seconds.

The signal output S3 serves as an active 24V collective fault signal and indicates that at least one output has been switched off due to overcurrent. An internal device fault is also signalled by S3.

5.4 Functionality of 2-wire communication via S1/S2

The circuit breaker can be remotely controlled via a higher-level control system (e.g. PLC) using a serial bit pattern at signal input S1. At the same time, the operating and fault statuses, the input voltage applied to the module, the set nominal current and the current flowing in each circuit are made available via the signal output S2.

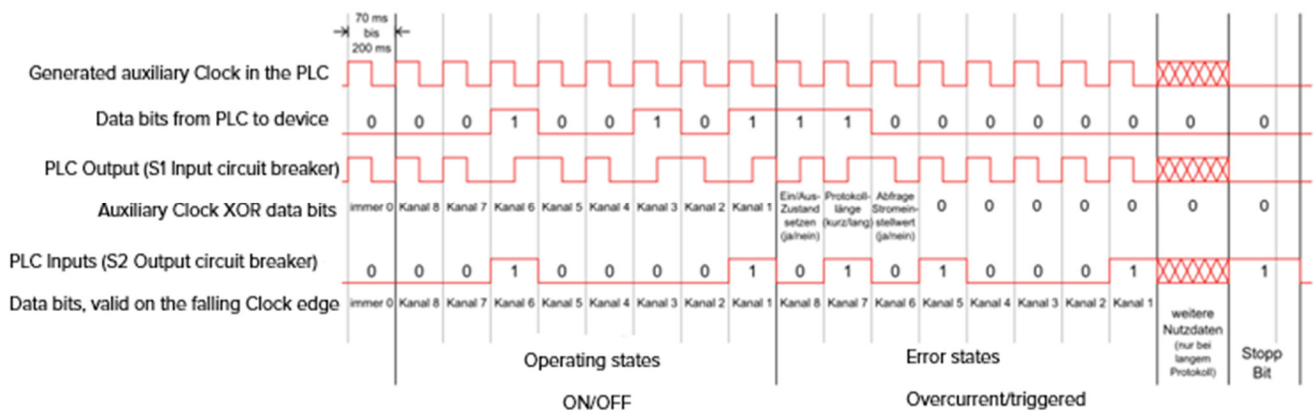

Diagnostic options via S1/S2:

Short protocol: (17 bit data - standard transmission time 1.2 seconds)
 Operating states = On or off per channel
 Error states = Triggered per channel

Extended protocol: (89 bit data - standard transmission time 6.3 seconds)
 Current input voltage
 Fixed rated currents per channel

Communication sequence via S1/S2

- A digital output of the control unit sends the Manchester coding to the circuit breaker via 'S1'. This encodes which output channel is to be switched on or off.
- The circuit breaker synchronises itself internally to this and simultaneously sends back the status (on/off and error status) of all channels via 'S2'. In addition to the module input voltage, the currently flowing current and the set current value of each circuit can optionally be queried, see 'Extended protocol'.
- The data sent back by the circuit breaker is only high/low and not Manchester-coded. The data should be accepted shortly after the edge change (from high to low) of the generated auxiliary clock in order to avoid false signalling due to program runtimes or delays of the I/Os in a PLC.
- Once all 17 or 89 bits for the extended protocol have been successfully received, the circuit breaker sends an 18th or 90th bit as a stop bit. This takes 1.5 clock cycles. During this time, the PLC must not send another bit.

Kodierung der vom Schutzschalter gesendeten Status-Bits

| On/Off status per channel | Error status per channel | Description |
|---------------------------|--------------------------|--------------------------------------------------------------------------|
| 0 | 0 | Output channel is switched off manually or via coded pulse pattern on S1 |
| 0 | 1 | Output channel is switched off due to an overcurrent |
| 1 | 0 | Output channel is switched on manually or via coded pulse pattern on S1 |

NOTES:

The on/off status changes sent by a higher-level control system are only sent back updated by the circuit breaker with the next telegram. If, for example, the status of output channel 3 is changed from '0' to '1' in a telegram, the old status '0' is transmitted in the same telegram. The status of the output channel is only sent updated by the circuit breaker the next time it is queried by the control system.

5.5 Details of signal input S1 (ON/OFF/RESET)

This 24V signal input is not electrically isolated in relation to the 0V input of the module. This input can be used to switch on all outputs that have been switched on due to an overload as well as to switch individual channels on or off.

Reset (reactivation of triggered channels)

By applying a 24 V voltage for longer than 0.5 seconds, all outputs triggered by an overload are switched on again sequentially and load-dependently.

Remote on/off

Any outputs can be switched on or off simultaneously using coded pulse patterns. Temporary circuits such as certain lights or auxiliary circuits can be switched off as required.

| Function | Action | Reaction | Impulse |
|----------|------------------------|--------------------------------------------------------------------------------------------------------------------------------------------------------------------------------------------------------------------------------------------------------|----------------------------------------------------------------------------------------------------------------------------|
| Reset | Long pulse >= 500ms | All outputs switched off due to overload are switched on again. Triggered channels are only reactivated after 0V detection. This prevents automatically triggered channels from being switched on again in the event of a continuous signal. |  Switching on all triggered channels |
| ON/OFF | Coded pulse pattern | Ein- und Ausschalten nicht ausgelöster Ausgänge Triggered outputs cannot be switched on or off. They must first be reset pulse beforehand. | See description of the pulse pattern below |

5.6 Two-wire interface

Advanced error detection

- If the high or low level is too long/short, the protocol is discarded and the system waits for the start condition (200ms low level)
- If transmission continues on S1 during the stop bit (S2), the protocol is discarded
- If the period duration changes from one protocol to the next more than the jitter allows (30%), the protocol is initially discarded. Only when the same period duration is detected a second time is the protocol accepted
- The check bit and the reserve bits must be consistent for two consecutive protocols.
- The new communication is downwards compatible with the previous two-wire interface as of 08.2024 and makes it more robust against faulty / incomplete signals

Description pulse pattern

The pulse pattern consists of 17 or optionally 89 bits, which must be sent as a Manchester code (according to IEEE 802.3) must be sent. The first bit to be transmitted has the value '0' and serves as the start bit. This is followed by 16 or optionally 88 bits of user data.

The first 8 bits represent the desired on/off status of the individual channels in descending order. A value of '1' switches the corresponding channel on, a value of '0' switches it off. For the following 8 bits, only the first three most significant bits are relevant.

- Bit 7 = „1“: the on/off status transmitted in the first 8 bits is accepted
- Bit 7 = „0“: the on/off status transmitted in the first 8 bits is ignored
- Bit 6 = „1“: the extended 89-bit protocol is used, the circuit breaker transmits additional user data
- Bit 6 = „0“: the short 17-bit protocol is used
- Bit 5 = „1“: the fixed rated currents and the current input voltage are transmitted
- Bit 5 = „0“: the current input voltage and, for all circuit-breakers in the „BASIC SMART“ configuration, the current output currents are transmitted. The following 6 or optionally 78 bits must be set to „0“ and serve as a clock signal for the signal output „S2“.

Once all 17 or 89 bits have been successfully received, the circuit breaker sends an 18th or 90th bit as a stop bit. This takes 1.5 clock cycles. During this time, the PLC must not send another bit. After the pulse pattern has been sent, S1 and S2 are set to low level again.

New pulse patterns on S1 are only permitted after a waiting time of at least 200 ms.

Standard protocol (17 Bit)

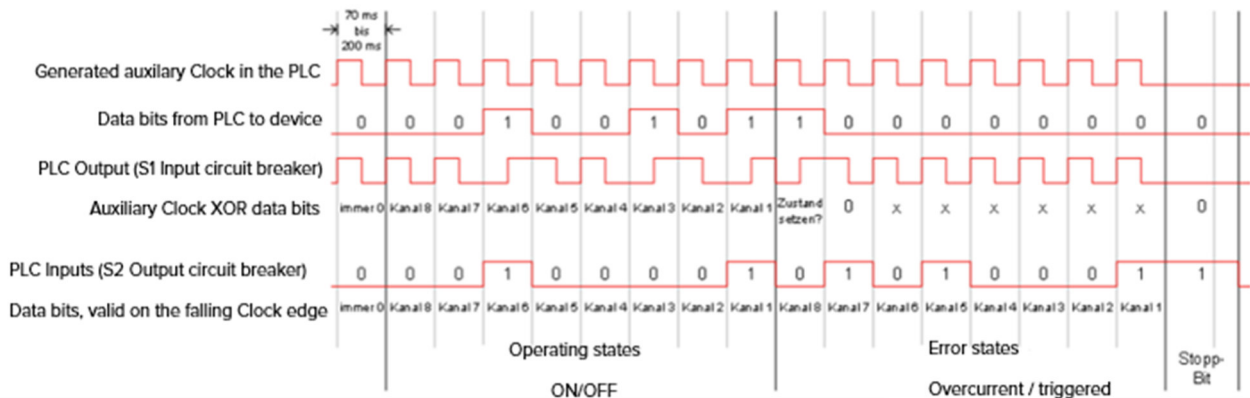

Erweitertes Protokoll (89 Bit)

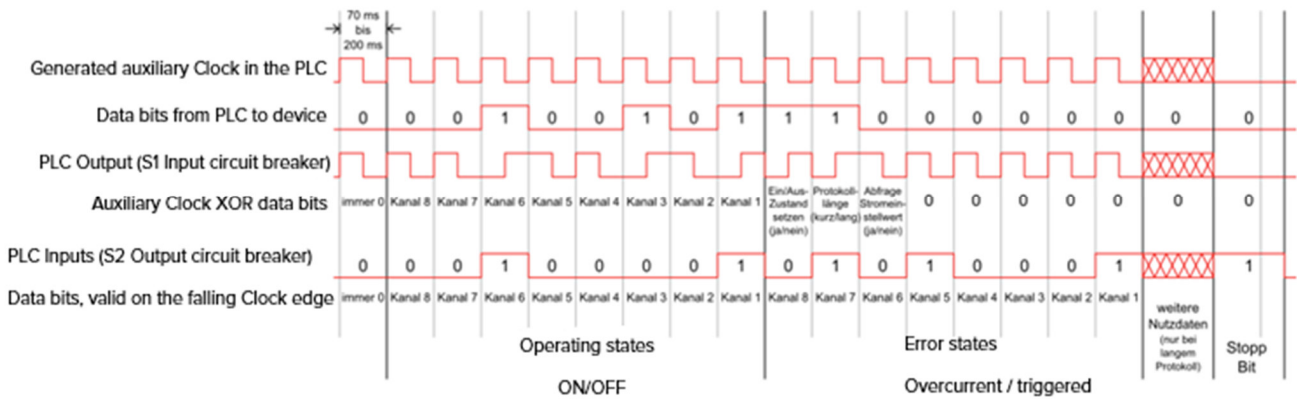

It begins with the 3rd byte of the protocol (further user data) and contains a total of 9 bytes. These are coded with the most significant bit first ('MSB first') and have the following meaning:

(Depending on the value of bit 5 in the 2nd byte, either the nominal currents or the current output currents (only 'BASIC SMART' equipment) are transmitted in addition to the current input voltage.

- Input voltage: ((transmitted value) /16 + 16) V
- Current channel 1: (transmitted value) /16 A
- Current channel 2: (transmitted value) /16 A
- Current channel 3: (transmitted value) /16 A
- Current channel 4: (transmitted value) /16 A
- Current channel 5: (transmitted value) /16 A
- Current channel 6: (transmitted value) /16 A
- Current channel 7: (transmitted value) /16 A
- Current channel 8: (transmitted value) /16 A

5.7 Details on signal output S2 (status of the outputs)

This 24V signal output is not electrically isolated in relation to the 0V input of the module. This output can be used to query the status of all integrated output channels. The output is short-circuit-proof, the short-circuit current is approx. 25 mA.

Coded pulse sequence for status enquiry, generated by the PLC

This 24V signal output is not electrically isolated in relation to the 0V input of the module. This output can be used to query the status of all integrated output channels. The output is short-circuit-proof, the short-circuit current is approx. 25 mA.

Cyclical pulse after status change, generated by the circuit breaker

If the PLC does not perform a cyclical status request, the circuit breaker on S2 generates a cyclical pulse if the error status changes and the status is not requested regularly within the next 3 seconds. The internal fault status changes when at least one output is switched off or overcurrent occurs. This pulse is sent until the PLC has successfully queried the updated status via a new Manchester-coded telegram.

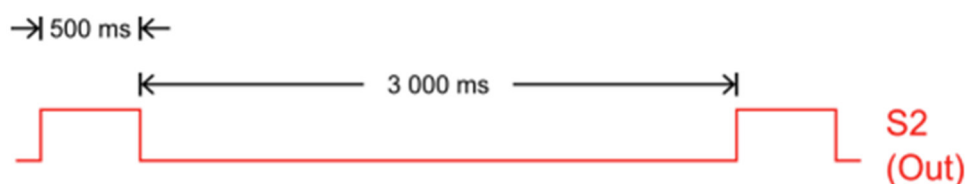

A digital input of the control system must therefore query the signal contact S2 in order to be informed of status changes in the circuit breaker. At the same time, the control system must be programmed to avoid starting a telegram via S1 while a pulse is being generated on S2 by the circuit breaker. It is recommended to evaluate the respective status on S2 before starting to send the telegram or to generate a telegram to query the status at least every 3 seconds.

5.8 Details on signal output S3 (Σ for triggered outputs and device fault)

Dieser 24V Signalausgang ist bezogen auf den 0V-Eingang des Moduls nicht potenzialgetrennt. Die Summenmeldung wird durch einen „Active High“ Signalausgang realisiert. Sofern kein Ausgang ausgelöst hat und kein interner Gerätedefekt detektiert wurde, ist dieser Signalausgang „Active High“ (+24V). Sobald mindestens ein Ausgangskanal ausgelöst hat oder ein Gerätedefekt erkannt wurde, schaltet der Signalausgang auf „Active Low“ (0V) um. Dieser Signalausgang ist kurzschlussfest und bis max. 20 mA belastbar.

6. Functional diagram

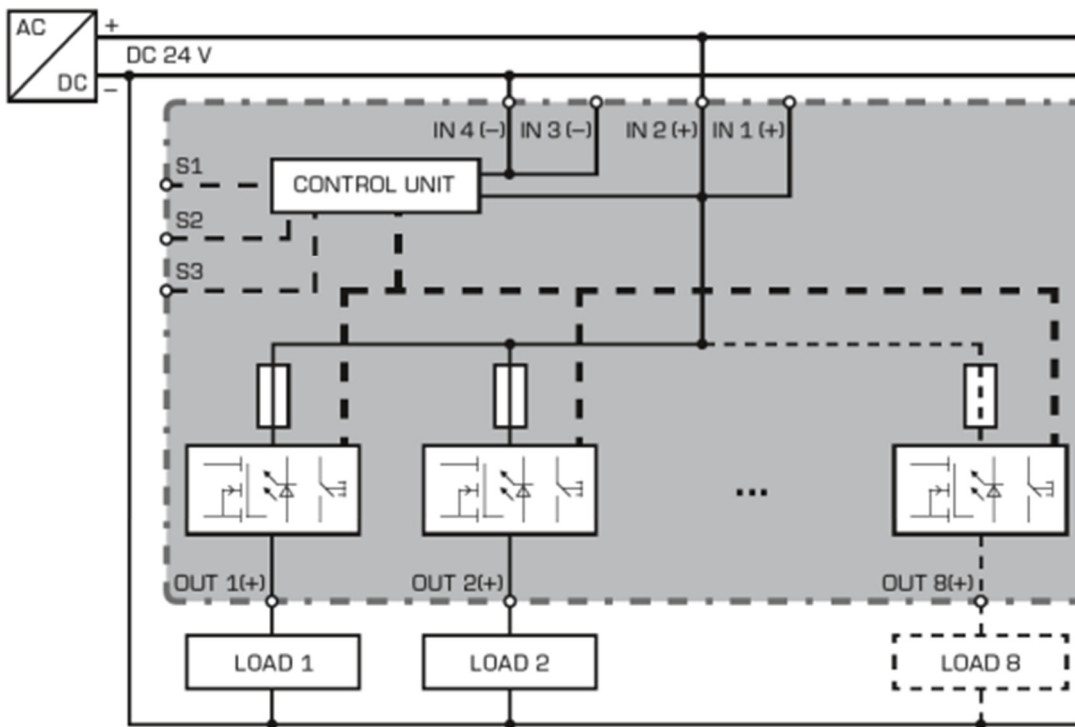

Functional diagram

7. Dimensions

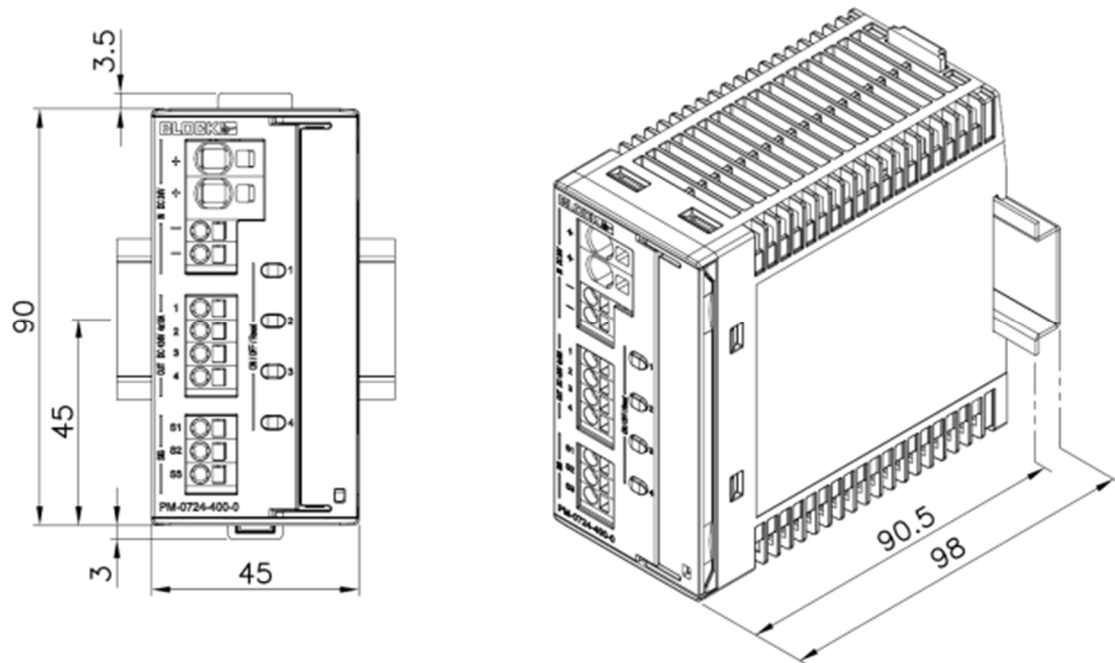

Dimensions 4 / 2 Channel-modules