

MANUAL

EB-IO-LINK
EB-COMMUNICATION MODULE



Easy-B Circuit breaker
EB-IO-LINK

TABLE OF

CONTENTS

1... ORDERING DATA.. 3

2. .. GENERAL INFORMATIONS	4
2.1 Safety instructions	4
2.2 Qualified personnel	4
2.3 Intended use	4
2.4 Disclaimer.....	4
3. .. Produktdescription	6
3.1 Description of the communication modules	6
3.2 System structure	7
3.3 Dimensioning.....	8
3.4 Assembly.....	8
3.5 Connections and Signalling	9
4. .. Commissioning	10
4.1 Operating States.....	10
4.2 Communication	11
5. .. Process data and parameters	11
5.1 Process data.....	12
5.2 Acyclic I/O data of the communication module.....	14
5.3 Acyclic I / O data of the network.....	15
5.3.1 Coding of the circuit breaker currents.....	16
5.3.2 Coding of the circuit breaker	16
5.3.3 Coding of the circuit breakers options	17
5.3.4 Coding of the circuit breaker types.....	18
5.3.5 Coding of the gateway options.....	19
5.3.6 Coding of the circuit breaker commands	20
5.3.7 Coding for resetting the circuit breaker trip counter	20

1. ORDERING DATA

The following table shows the ordering data for the charging and control unit and the battery modules.

Table 1: Order numbers

Variant	Input voltage	Channels
EB-IO-LINK	24 Vdc	40
EB-IO-LINK 1	24 Vdc	16

2. GENERAL INFORMATIONS

2.1 Safety instructions

Please read these warnings and safety instructions carefully before operating the appliance. The device may only be installed by specialised and qualified personnel. In the event of malfunctions or damage, switch off the supply voltage immediately and send the device to BLOCK Transformatoren-Elektronik GmbH for inspection. The device does not contain any service parts. If an internal fuse blows, there is most probably an internal defect in the appliance. The data given are for product description purposes only and are not to be regarded as warranted characteristics in the legal sense.

2.2 Qualified personnel

The product associated with this documentation may only be handled by qualified personnel in compliance with the documentation associated with the respective task, in particular the safety instructions and warnings contained therein. Qualified personnel can ensure, based on their training and experience, that the use of the described product fulfils all safety requirements as well as the applicable provisions, regulations, standards and laws.

2.3 Intended use

This device is designed for installation in an enclosure and is suitable for use in general electronic devices, such as industrial control systems, office equipment, communication devices or measuring devices. Do not use this device in the control systems of aeroplanes, trains or nuclear facilities where a malfunction could result in serious injury or danger to life.

2.4 Disclaimer

The contents of this publication have been checked with the utmost care to ensure that they correspond to the hardware and software described. Nevertheless, there may be discrepancies between the product and the documentation. Deviations may also occur due to the continuous further development of the product. For this reason, we cannot guarantee complete conformity. Should this documentation contain errors, we reserve the right to make any necessary corrections without prior notice.



ATTENTION

Switch off the input voltage before carrying out installation, maintenance or modification work and secure it against unintentional switching on again.



ATTENTION

Do not make any changes or attempts to repair the appliance. Do not open the device!



ATTENTION

Prevent the ingress of foreign objects such as paper clips and metal parts.



ATTENTION

Do not operate the appliance in a damp environment or in an environment where condensation or condensation is to be expected.



ATTENTION

Do not touch the housing during operation or shortly after switching off.
Hot surfaces can cause injuries.

3. Produktdescription

3.1 Description of the communication modules

The EB-IO-LINK communication module serves as an interface for connection to a higher-level control system and is compatible with EB-08, EB-17, EB-18 and EB-38 circuit breakers.

The communication module supports the IO-Link standard V1.1 and operates at COM 3 speed of 230.4 kB. The cyclic data exchange is 2.0 ms and contains 6 bytes of process data.

To ensure error-free operation, the maximum number of 40 circuit breakers must not be exceeded.

3.2 System structure

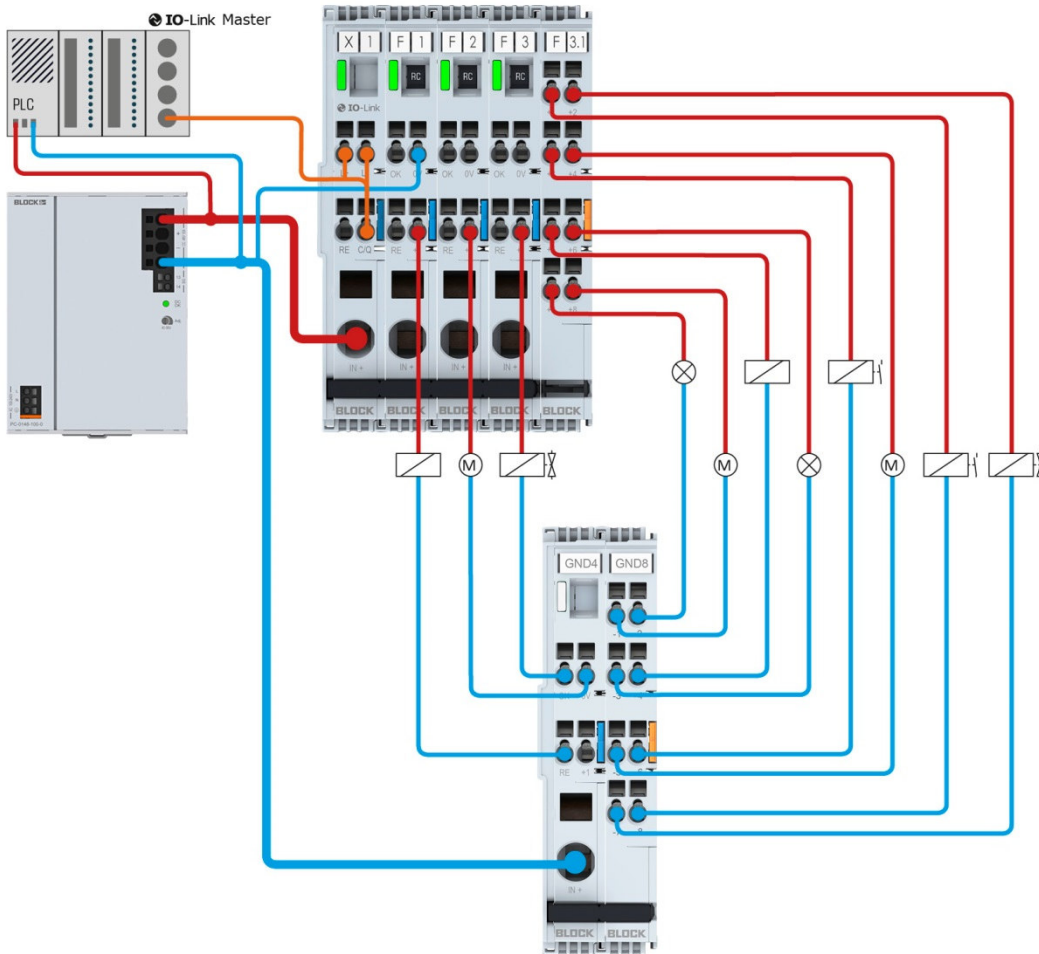

Figure 1 Structure of a network with EB-GND4/8

Modules used in the system structure:

X1	EB-IO-LINK
F1	EB-0824-100-0
F2	EB-0824-100-0
F3	EB-0824-100-0
F3.1	EB-PMM
GND4	EB-GND4
GND8	EB-GND8

NOTE:

Deviating wiring can lead to the destruction of the modules.
The IO-LINK cable must not exceed a maximum length of 20 metres.

3.3 Dimensioning

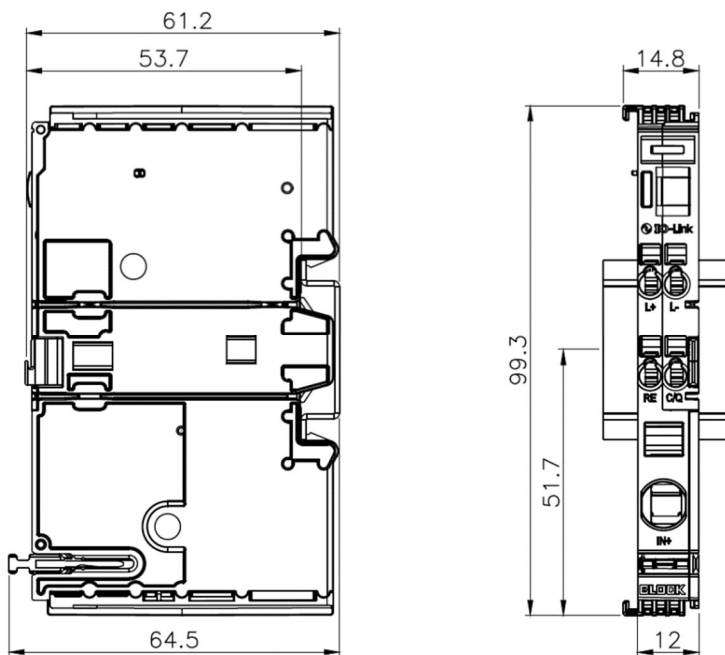

Figure 2: Dimensioning IO-LINK

3.4 Assembly

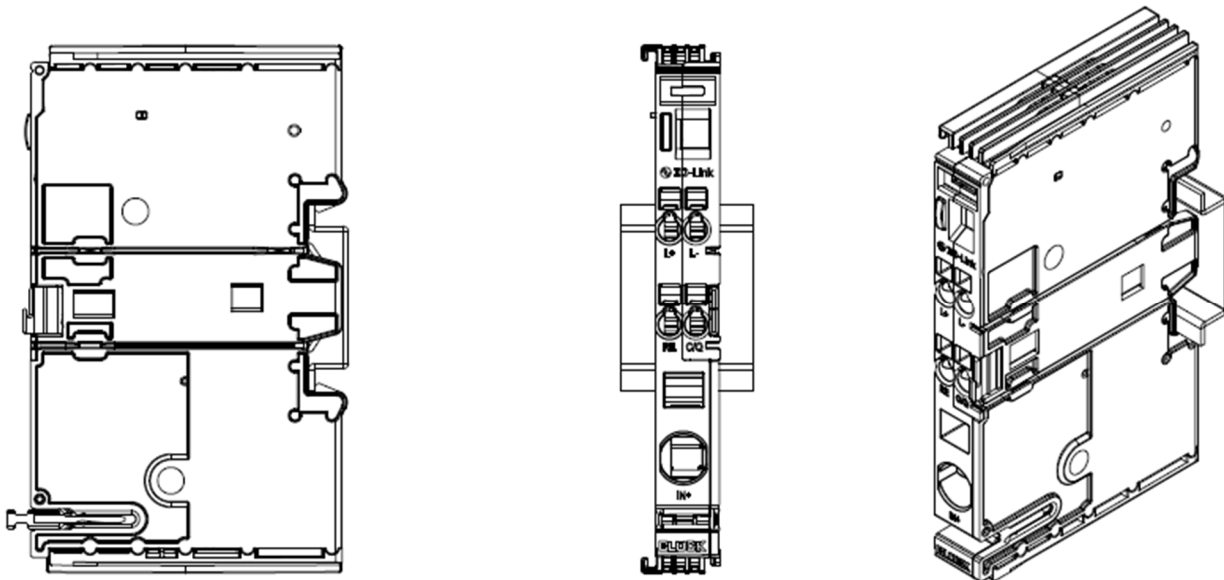

Figure 3: Assembly

3.5 Connections and Signalling

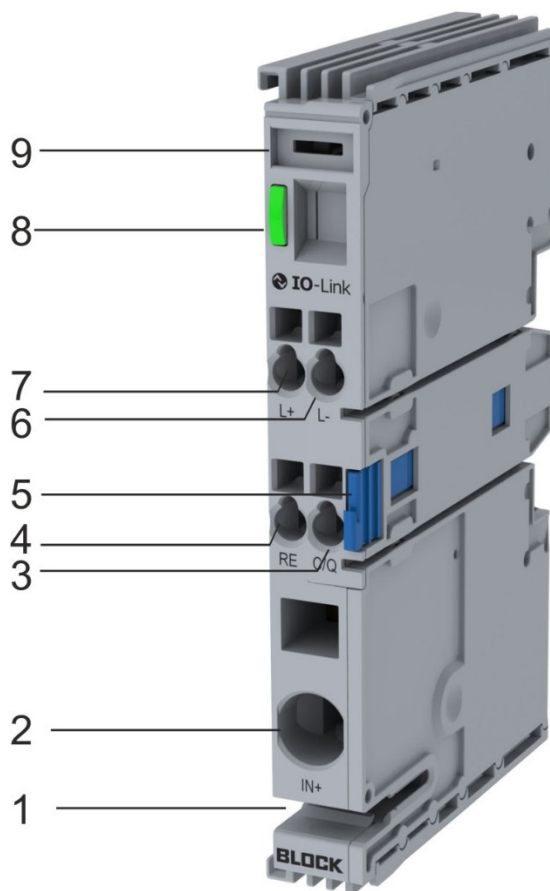

Figure 4: Overview of the connections and signalling

- 1) Mounting cross connector EB-BAR
- 2) Feed terminal up to max. 40A
- 3) Communication C/Q
- 4) Reset input RE
- 5) Release tab
- 6) Communication L-
- 7) Communication L+
- 8) Signalling LED
- 9) Labelling field

4. Commissioning

The EB-IO-LINK module initialises itself automatically by applying the supply voltage to the IN+ terminal or by establishing the IO-Link connection.

Functional operation is only possible by connecting circuit breaker modules and applying the supply voltage to IN+.

After the supply voltage is applied, all connected circuit breakers are addressed in sequence and then switched on selectively in sequence.

Using the IO-Link module, a maximum of up to 40 circuit breaker channels can be addressed and managed.

To simplify commissioning and project planning, the associated IODD can be downloaded from the following link.

NOTES:

When applying the supply voltage to IN+, it is essential that a separate GND line is connected to one of the circuit breaker channels.

Commissioning without connected circuit breaker modules can lead to incorrect behaviour.

4.1 Operating States

The EB-IO-LINK module has an LED to indicate the respective operating status.

Figure 1 Operating states

Operating status	Signalling LED	Remark
Switched on, offline	Flashing green	Network is switched on and addressed, no IO-Link communication
Switched on, online	Glowing green	Network is switched on and addressed, IO-Link communication is established
Off	Off	No supply voltage or IO-Link connection

4.2 Communication

The EB-IO-LINK communication module communicates in accordance with the IO-LINK standard V1.1 and is downwards compatible with the IO-LINK standard V1.0.1.

An IO-Link master in version V1.1 or V1.0 is required for communication with the communication module and the network connected to it.

The communication module operates in COM 3 mode (230.4 kB) and exchanges 6 bytes of process data with the master per cycle (2 ms).

5. Process data and parameters

The EB-IO-LINK module has 6 bytes of process data that are exchanged with the master every 2 ms. The structure and organisation of this data is described in detail in chapter 5.1.

In addition to the process data, the parameter and diagnostic data of each individual circuit breaker channel is transmitted, see Chapter 5.2 and Chapter 5.3.

5.1 Process data

The process data is exchanged with the IO-Link master in a cycle of 2ms at 230400 baud. The process data consists of a total of 6 bytes. The coding of the individual bytes can be found in Tables 2 -8.

Table 3 Process data Collective Events Byte 1

Byte 1	MSB				LSB			
Description	Bit 7	Bit 6	Bit 5	Bit 4	Bit 3	Bit 2	Bit 1	Bit 0
00 Collective Message Channel Tripped / Switched Off	0	0	0	0	0	0	0	1
01 Collective Message Current >90% Nominal	0	0	0	0	0	0	1	0
02 Group Reset	0	0	0	0	0	1	0	0
03 Internal Communication Failure*	0	0	0	0	1	0	0	0
04 Reserved	0	0	0	1	0	0	0	0
05 Reserved	0	0	1	0	0	0	0	0
06 Reserved	0	1	0	0	0	0	0	0
07 Input Voltage Alarm	1	0	0	0	0	0	0	0

*Bit is set if addressing has not been successfully completed.
System restart required.

Table 2 Process data eBreaker tripped Byte 2

Byte 2	MSB				LSB			
Description	Bit 7	Bit 6	Bit 5	Bit 4	Bit 3	Bit 2	Bit 1	Bit 0
08 eBreaker 01 Tripped	0	0	0	0	0	0	0	1
09 eBreaker 02 Tripped	0	0	0	0	0	0	1	0
10 eBreaker 03 Tripped	0	0	0	0	0	1	0	0
11 eBreaker 04 Tripped	0	0	0	0	1	0	0	0
12 eBreaker 05 Tripped	0	0	0	1	0	0	0	0
13 eBreaker 06 Tripped	0	0	1	0	0	0	0	0
14 eBreaker 07 Tripped	0	1	0	0	0	0	0	0
15 eBreaker 08 Tripped	1	0	0	0	0	0	0	0

Table 3 Process data eBreaker tripped Byte 3

Byte 3	MSB				LSB			
Description	Bit 7	Bit 6	Bit 5	Bit 4	Bit 3	Bit 2	Bit 1	Bit 0
16 eBreaker 09 Tripped	0	0	0	0	0	0	0	1
17 eBreaker 10 Tripped	0	0	0	0	0	0	1	0
18 eBreaker 11 Tripped	0	0	0	0	0	1	0	0
19 eBreaker 12 Tripped	0	0	0	0	1	0	0	0
20 eBreaker 13 Tripped	0	0	0	1	0	0	0	0
21 eBreaker 14 Tripped	0	0	1	0	0	0	0	0
22 eBreaker 15 Tripped	0	1	0	0	0	0	0	0
23 eBreaker 16 Tripped	1	0	0	0	0	0	0	0

Table 4 Process data eBreaker tripped Byte 4

Byte 4	MSB				LSB			
Description	Bit 7	Bit 6	Bit 5	Bit 4	Bit 3	Bit 2	Bit 1	Bit 0
24 eBreaker 17 Tripped	0	0	0	0	0	0	0	1
25 eBreaker 18 Tripped	0	0	0	0	0	0	1	0
26 eBreaker 19 Tripped	0	0	0	0	0	1	0	0
27 eBreaker 20 Tripped	0	0	0	0	1	0	0	0
28 eBreaker 21 Tripped	0	0	0	1	0	0	0	0
29 eBreaker 22 Tripped	0	0	1	0	0	0	0	0
30 eBreaker 23 Tripped	0	1	0	0	0	0	0	0
31 eBreaker 24 Tripped	1	0	0	0	0	0	0	0

Table 5 Process data eBreaker tripped Byte 5

Byte 5	MSB				LSB			
Description	Bit 7	Bit 6	Bit 5	Bit 4	Bit 3	Bit 2	Bit 1	Bit 0
32 eBreaker 25 Tripped	0	0	0	0	0	0	0	1
33 eBreaker 26 Tripped	0	0	0	0	0	0	1	0
34 eBreaker 27 Tripped	0	0	0	0	0	1	0	0
35 eBreaker 28 Tripped	0	0	0	0	1	0	0	0
36 eBreaker 29 Tripped	0	0	0	1	0	0	0	0
37 eBreaker 30 Tripped	0	0	1	0	0	0	0	0
38 eBreaker 31 Tripped	0	1	0	0	0	0	0	0
39 eBreaker 32 Tripped	1	0	0	0	0	0	0	0

Table 6 Process data eBreaker tripped Byte 6

Byte 6	MSB				LSB			
Description	Bit 7	Bit 6	Bit 5	Bit 4	Bit 3	Bit 2	Bit 1	Bit 0
40 eBreaker 33 Tripped	0	0	0	0	0	0	0	1
41 eBreaker 34 Tripped	0	0	0	0	0	0	1	0
42 eBreaker 35 Tripped	0	0	0	0	0	1	0	0
43 eBreaker 36 Tripped	0	0	0	0	1	0	0	0
44 eBreaker 37 Tripped	0	0	0	1	0	0	0	0
45 eBreaker 38 Tripped	0	0	1	0	0	0	0	0
46 eBreaker 39 Tripped	0	1	0	0	0	0	0	0
47 eBreaker 40 Tripped	1	0	0	0	0	0	0	0

5.2 Acyclic I/O data of the communication module

The acyclic I/O data is information that can be queried directly by the EB-IO-LINK communication module. The query is carried out using a function block provided by the IO-LINK master manufacturer.

In addition to the standard information (up to index 37), parameters can be specified and retrieved here, shown below in **Table 8**:

Table 9 Acyclic I/O d

Index dec	Functions	Data typ	Attribute	Remark
16	Vendor Name	String	RO	IO-Link interface and system specification V1.1.2
17	Vendor Text	String	RO	IO-Link interface and system specification V1.1.2
18	Product Name	String	RO	IO-Link interface and system specification V1.1.2
19	Product Id	String	RO	IO-Link interface and system specification V1.1.2
20	Product Text	String	RO	IO-Link interface and system specification V1.1.2
21	Product Serial Number	String	RO	IO-Link interface and system specification V1.1.2
22	Hardware Revision	String	RO	IO-Link interface and system specification V1.1.2
23	Firmware Revision	String	RO	IO-Link interface and system specification V1.1.2
24	Application Specific Tag	String	R/W	IO-Link interface and system specification V1.1.2
32	Error Count	16 Bit	RO	IO-Link interface and system specification V1.1.2
36	Device Status	8 Bit	RO	IO-Link interface and system specification V1.1.2
37	Detailed Device Status	String	RO	IO-Link interface and system specification V1.1.2
81	Gateway Options	8 Bit	R/W	Options of the communication module
90	Input Voltage	16 Bit	RO	Input voltage level at the supply terminal
91	Number of Nodes	8 Bit	RO	Number of addressed circuit breakers
100	ThresholdCriticalInputVoltageMax	16 Bit	R/W	Upper limit for input voltage alarm
101	ThresholdCriticalInputVoltageMin	16 Bit	R/W	Lower limit for input voltage alarm
102	Events Enable	8 Bis	R/W	Events for the first process data byte

5.3 Acyclic I / O data of the network

The acyclic I/O data is information that can be obtained directly from the circuit breaker channels, shown below in **Table 9**.

The different coding of the data is shown below.

Table 10 Acyclic I/O data network



Index dec	Functions	Data typ	Attribute	Remark
70	eBreaker RC_Status 1-8	8 Bit	RO	Test bit for setting the current
71	eBreaker RC_Status 9-16	8 Bit	RO	Test bit for setting the current
72	eBreaker RC_Status 17-24	8 Bit	RO	Test bit for setting the current
73	eBreaker RC_Status 25-32	8 Bit	RO	Test bit for setting the current
74	eBreaker RC_Status 33-40	8 Bit	RO	Test bit for setting the current
80	eBreaker Command(ON/OFF/RESET)	8Bit	WO	Switching on / switching off / resetting the individual circuit breakers
82	eBreaker Set Options to ALL	8Bit	WO	Transferring the first circuit breaker options to all modules
83	eBreaker Reset Trip Counter 1-40	8Bit	WO	Resetting the trip counter. Automatically 0 after restart
201 - 240	eBreaker Trip Counter	8Bit	RO	Trip counter of the circuit breaker
301 - 340	eBreaker Current	16Bit	RO	ACTUAL current
401 - 440	eBreaker Trip Current	8Bit	RW	Triggering current
501 - 540	eBreaker Status	8Bit	RO	Status of the circuit breakers (see Table 10)
601 - 640	eBreaker Software Version	16Bit	RO	Software version of the circuit breaker
701 - 740	eBreaker Options	16Bit	RW	Options of the circuit breaker
801 - 840	eBreaker Production Number	String	RO	Production number of the circuit breaker
901 - 940	eBreaker Type	8Bit	RO	Type designation of the circuit breaker

5.3.1 Coding of the circuit breaker currents

The coding of the tripping currents (index 401 - 416) is shown in **Table 10**:

Table 11 Coding of the currents

Dec. value	Functions	Remark	IODD Version	
0	Default	IODD DEFAULT	EB-IO-LINK1_IODD_V01 EB-IO-LINK_IODD_V02	EB-IO-LINK1_IODD_V02 EB-IO-LINK_IODD_V03
5	0.5	Trigger current 0.5A		
10	1	Trigger current 1A		
20	2	Trigger current 2A		
30	3	Trigger current 3A		
40	4	Trigger current 4A		
50	5	Trigger current 5A		
60	6	Trigger current 6A		
80	8	Trigger current 8A		
100	10	Trigger current 10A		
75	7,5	Trigger current 7,5A		

 IODD FW: Version up to 1.10
 IODD FW: Version as of 1.10

5.3.2 Coding of the circuit breaker

The coding of the status (index 501 - 540) is shown in **Table 11**:

Table 12 Coding of the status

Dec. Value	Functions	IODD Version	Dec Value	Functions	IODD Version
0	Not connected	EB-IO-LINK1_IODD_V01 EB-IO-LINK_IODD_V02	0	Not connected	EB-IO-LINK1_IODD_V02 EB-IO-LINK_IODD_V03
1	Switched off via interface		1	Switched off via interface	
2	Switched on		2	Switched on	
3	Triggered		3	Triggered	
6	Current >90% nominal		6	Output current >90% of the rated current	
14	Current >100% nominal		14	Output current >100% of the rated current	
18	Hardware error		18	Hardware error	
20	Thermal relaxation		20	Thermal relaxation	
50	Switched off Local		50	Switched off Local	

NOTES:



If a circuit breaker has been switched off locally, it can only be switched on again locally. This functionality is used for safety when working on the system.

5.3.3 Coding of the circuit breakers options

The coding of the options (index 701 - 740) is shown in **Table 12**.

Table 12 Coding of the options

Number	Description	MSB1				LSB1				MSB0				LSB0				IODD Version
		Bit 7	Bit 6	Bit 5	Bit 4	Bit 3	Bit 2	Bit 1	Bit 0	Bit 7	Bit 6	Bit 5	Bit 4	Bit 3	Bit 2	Bit 1	Bit 0	
1	OK signal when channel is triggered	0	0	0	0	0	0	0	0	0	0	0	0	0	0	0	0	Yellow
	OK signal status when channel is triggered/switched off	0	0	0	0	0	0	0	0	0	0	0	0	0	0	0	1	
2	OK signal 'HIGH' for error	0	0	0	0	0	0	0	0	0	0	0	0	0	0	0	0	Yellow
	OK signal 'LOW' for error	0	0	0	0	0	0	0	0	0	0	0	0	0	0	1	0	
3	Automatic addressing ON	0	0	0	0	0	0	0	0	0	0	0	0	0	0	0	0	Green
	Automatic addressing OFF	0	0	0	0	0	0	0	0	0	0	0	0	0	1	0	0	
4	Release behaviour of the SLOW fuse	0	0	0	0	0	0	0	0	0	0	0	0	0	0	0	0	Green
	Release behaviour of the FAST fuse	0	0	0	0	0	0	0	0	0	0	0	0	1	0	0	0	
5	OK signal as collective status message	0	0	0	0	0	0	0	0	0	0	0	0	0	0	0	0	Green
	OK signal as a single status signal	0	0	0	0	0	0	0	0	0	0	0	1	0	0	0	0	
6	RE as normal input	0	0	0	0	0	0	0	0	0	0	0	0	0	0	0	0	Green
	RE as control input for maintenance	0	0	0	0	0	0	0	0	0	0	1	0	0	0	0	0	
7	24V operating mode	0	0	0	0	0	0	0	0	0	0	0	0	0	0	0	0	Green
	12V operating mode	0	0	0	0	0	0	0	0	0	1	0	0	0	0	0	0	

 IODD FW: Version up to 1.10
 IODD FW: Version as of 1.10

Explanation of circuit breaker options 1 -7

1. selection between only triggered channels or triggered and manually switched off channels for the OK signal. **FACTORY SETTING: 1**
2. Selection for the type of signal OK output. **FACTORY SETTING: 1**
3. Each time the system is restarted, the system is automatically addressed. If this is not necessary, it can be prevented. **FACTORY SETTING: 0**
4. Switching between fast characteristic curve and slow characteristic curve. **FACTORY SETTING: EB-x7 = 1 , EB-x8 = 0**
5. Behaviour of the OK signal status. **FACTORY SETTING: 0**
6. When 0 V is applied, the circuit breaker goes into maintenance mode and switches off all loads. As soon as 24 V is applied, all loads are supplied again. **FACTORY SETTING: 0**
7. 12 V is ready, but not active. **FACTORY SETTING: 0**

Number	Description	MSB1				LSB1				MSB0				LSB0				IODD Version
		Bit7	Bit6	Bit5	Bit4	Bit3	Bit2	Bit1	Bit0	Bit7	Bit6	Bit5	Bit4	Bit3	Bit2	Bit1	Bit0	
1	Tripped / Tripped OFF	0	0	0	0	0	0	0	0	0	0	0	0	0	0	0	0	0
		0	0	0	0	0	0	0	0	0	0	0	0	0	0	0	0	1
2	OK inverted / non inverted	0	0	0	0	0	0	0	0	0	0	0	0	0	0	0	0	0
		0	0	0	0	0	0	0	0	0	0	0	0	0	0	0	1	0
3	Auto Addr On / Off	0	0	0	0	0	0	0	0	0	0	0	0	0	0	0	0	0
		0	0	0	0	0	0	0	0	0	0	0	0	0	1	0	0	0

NOTE:

The circuit breaker options correspond to 3 (dec) in the delivery state, i.e. the first two options are set. The 'Auto Addr On / Off' option is only available from circuit breaker firmware version 1.12 (RO) and indicates whether automatic address assignment is switched on or off.



5.3.4 Coding of the circuit breaker types

The coding of the types (index 901 - 940) is shown in **Table 13**.





Table 13 Coding of the types



Dec. Value	Designation	IODD Versions Name	
170	EB-3824-100-0	EB-IO-LINK1_IODD_V01 EB-IO-LINK_IODD-V02	EB-IO-LINK1_IODD_V02 EB-IO-LINK_IODD_V03
138	EB-0824-100-0		
145	EB-1824-010-0		
146	EB-1824-020-0		
147	EB-1824-030-0		
148	EB-1824-040-0		
150	EB-1824-060-0		
152	EB-1824-080-0		
154	EB-1824-100-0		
193	EB-1724-010-0F		
194	EB-1724-020-0F		
195	EB-1724-030-0F		
196	EB-1724-040-0F		
198	EB-1724-060-0F		
199	EB-1724-075-0F		
200	EB-1724-080-0F		
202	EB-1724-100-0F		
234	EB-3724-100-0F		

Dec. Value	Designation	IODD Versions Name	
209	EB-1724-2020-0F		
210	EB-1724-2040-0F		
211	EB-1724-2060-0F		
212	EB-1724-2080-0F		
214	EB-1724-2120-0F		
215	EB-1724-2150-0F		
216	EB-1724-2160-0F		
248	EB-3724-2160-0F		
155	EB-1724-120-0F		
156	EB-1724-140-0F		
157	EB-1724-150-0F		
158	EB-1724-160-0F		
173	EB-3724-150-0F		
174	EB-3724-160-0F		
141	EB-0724-150-0F		
142	EB-0724-160-0F		
186	EB-0724-100-0F		

 IODD FW: Version up to 1.10
 IODD FW: Version as of 1.10

5.3.5 Coding of the gateway options

Number	Description	MSB0				LSB0				IODD Version	
		Bit 7	Bit 6	Bit 5	Bit 4	Bit 3	Bit 2	Bit 1	Bit 0		
1	Automatic address on	0	0	0	0	0	0	0	0		
	Automatic address off	0	0	0	0	0	0	0	1		
2	24 V operating mode on	0	0	0	0	0	0	0	0		
	12 V operating mode off	0	0	0	0	0	0	1	0		

 IODD FW: Version up to 1.10
 IODD FW: Version as of 1.10

5.3.6 Coding of the circuit breaker commands

The coding of the commands (index 80) is shown in **Table 30**:

Table 13 Coding of the commands

Dec. Value	Designation	Remark
1	ON	Channel 1 On
2	OFF	Channel 1 Off
3	RESET	Channel 1 Reset
6	ON	Channel 2 On
7	OFF	Channel 2 Off
8	RESET	Channel 2 Reset
11	ON	Channel 3 On
12	OFF	Channel 3 Off
13	RESET	Channel 3 Reset
...

NOTES:

The addresses of the channels are formed by an offset of decimal 5.

5.3.7 Coding for resetting the circuit breaker trip counter

The coding of the reset function (index 83) for the trip counter is shown in **Table 30**:

Table 14 Coding of the reset

Dec. Value	Functions	Remark
1	RESET	Channel 1 Reset Trip Counter
2	RESET	Channel 2 Reset Trip Counter
3	RESET	Channel 3 Reset Trip Counter
4	RESET	Channel 4 Reset Trip Counter
5	RESET	Channel 5 Reset Trip Counter
6	RESET	Channel 6 Reset Trip Counter
...

NOTES:

The addresses of the channels are formed by the channel numbers.