



Short circuit proof PCB transformer,
safety isolating transformer

DATA SHEET

VB 1,5/1/6

Type number

Order number	VB 1,5/1/6
Series	VB
Core size	EI 30/12,5

Technical data

Tapping	Voltage [V]	Current [A]	Fuse
Input 1	230		
Output 1	6	0.25	

General

Power	1.5 VA	Duty Cycle	100 %
Phases	1	No-Load Losses	0.9 W
Frequency range	50 up to 60 Hz	Wire material	Copper

Operating conditions

General

Short circuit proof	inherently short-circuit proof	Switching group	li0
Cooling type	AN		

Cited date	18.12.2024
Part number	VB 1,5/1/6
Page	1

BLOCK Transformatoren-Elektronik GmbH
Max-Planck-Straße 36-46
27283 Verden, Germany
Phone: +49 4231 678-0
www.block.eu

BLOCK 
perfecting power

Environment

Max. installation height	2,000 m	Transport temperature	-20 up to 85 °C
Ambient temperature	-20 up to 70 °C (UL: max. 40 °C)	EN Insulation class	B (130°C)
Storage temperature	-20 up to 85 °C	UL Insulation class	class 105

Protection & Safety

Protection type	IP 00	Degree of contamination	1
Protection class (prepared)	II	Overvoltage category	III

Mechanical data

Electrical Connections

Input terminal	Pin	Output terminal	Pin
----------------	-----	-----------------	-----

Size & Weight

Width	32.8 mm	Weight	0.083 kg
Height	24.4 mm	Core weight	0.057 kg
Depth	27.8 mm	Copper weight	0.02 kg

Dimensions

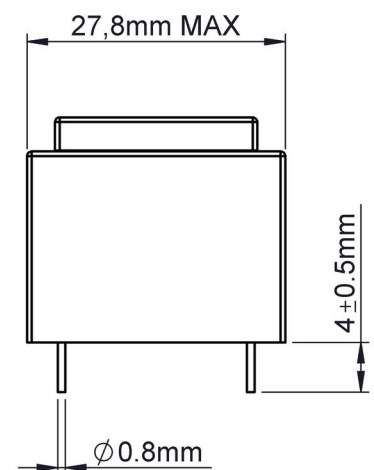
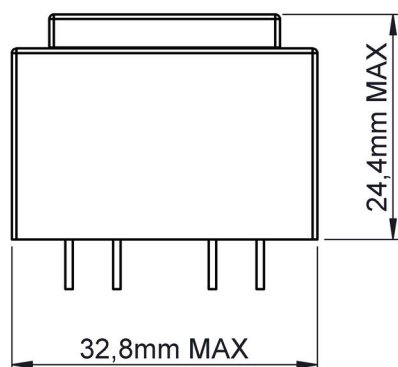
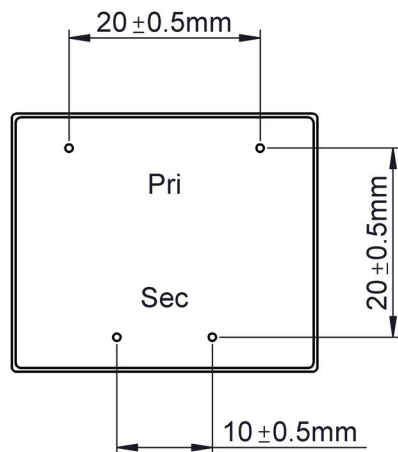

Cited date	18.12.2024
Part number	VB 1,5/1/6
Page	2

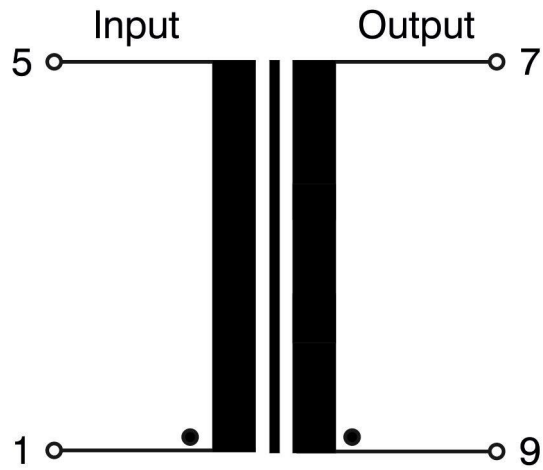

Derating - Installation height

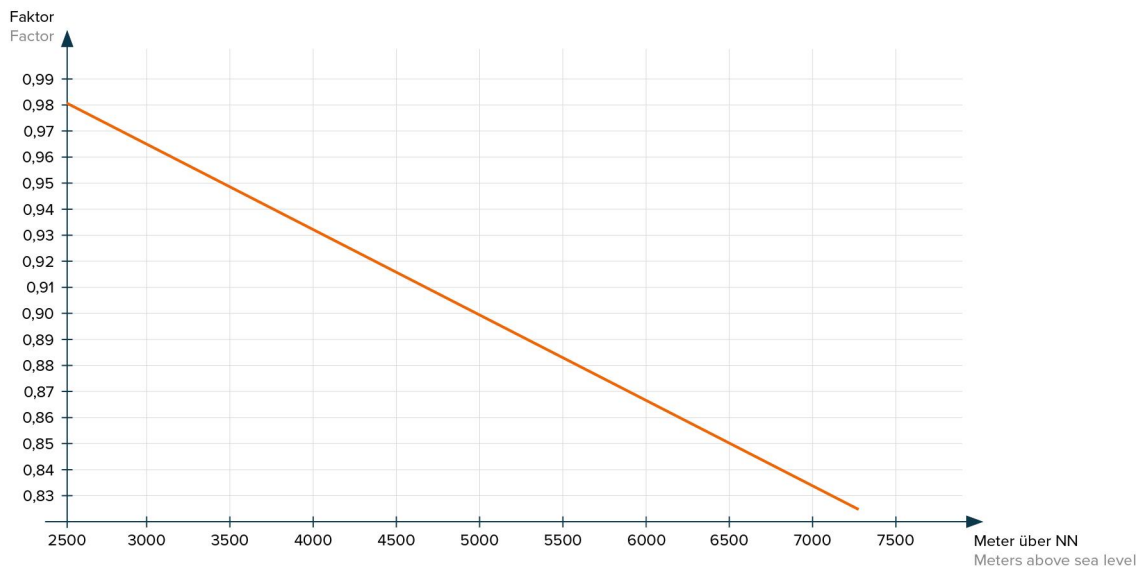

Standards and approvals



RoHS compliant



EN 61558-2-6
2009



CE compliant



VDE Approval



Approval cURus -
Recognized
UL 5085-1/-2;
CSA 22.2 E103521

Notes

Technical specifications are typical,
they can vary due to material and production tolerances.

Cited date 18.12.2024

Part number VB 1,5/1/6

Page 3

BLOCK Transformatoren-Elektronik GmbH
Max-Planck-Straße 36-46
27283 Verden, Germany
Phone: +49 4231 678-0
www.block.eu

