

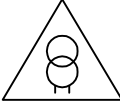



<b>Typ</b> Type	: 1~ <i>Steuer-und Sicherheitstransformator</i> 1~ Voltage control and safety isolating transformer		
<b>Kernform</b> Core type	: EI 150N/66,6		
<b>Bemessungsspannung, Eingang</b> Designated input voltage	: 400V ± 5%		
<b>Bemessungsstrom, Eingang</b> Designated input current	: 2,14Aac	(UL: 1,69Aac)	
<b>Bemessungsspannung, Ausgang</b> Designated output voltage	: 42V		
<b>Bemessungsstrom, Ausgang</b> Designated output current	: 19,0Aac	(UL: 15,0Aac)	
<b>Vorzusehende Absicherung, Ausgang</b> Recommended output fuse	:  20,0AgG		
<b>Einschaltdauer</b> Duty cycle	: 100%		
<b>Bemessungsleistung (bei Leistungsfaktor 1)</b> Designated output power (power factor 1)	: 800VA	(UL: 630VA)	
<b>Bemessungsleistung (bei Leistungsfaktor 0,5)</b> Designated output power (power factor 0.5)	: 2000VA		
<b>Verlustleistung</b> Power loss	: typ. 62W		
<b>Schaltgruppe</b> Connection mode	: Ii0		
<b>Betriebsfrequenz</b> Designated frequency	: 50-60Hz		
<b>Schutzklasse</b> Safety class	: <i>vorbereitet für Geräte der Schutzklasse I</i> prepared for class I equipment		
<b>Schutzart</b> Protection index	: IP00		
<b>Kühlungsart</b> Type of cooling	: AN		
<b>Isolierstoffklasse</b> Insulation index	: B (UL class 105)		
<b>Max. Umgebungstemperatur</b> Ambient temperature	: 40°C		
<b>Vorschriften</b> Standards	: EN 61558 Teil 1 mit Teil 2-2 und Teil 2-6 EN 61558 part 1 with part 2-2 and part 2-6		
<b>Prüfzeichen</b> Approvals	:  VDE 0570 Typ ST/S	:  UL 5085, CSA 22.2	(E 103521)
<b>Prüfspannung</b> HV-Test voltage	: Primär-Sekundär Primary-Secondary	: 4,8 kV	: Sekundär-Kern Secondary-Core
	: Primär-Kern Primary-Core	: 4,8 kV	: 3,0 kV
<b>Anschluss (Eingang)</b> Terminal (Input)	: Schraubklemme 4mm <sup>2</sup> Screw terminal 4mm <sup>2</sup>		
<b>Anschluss (Ausgang)</b> Terminal (Output)	: Schraubklemme 4mm <sup>2</sup> + Flachsteckanschluss 6,3x0,8mm Screw terminal 4mm <sup>2</sup> + Plug type terminal 6,3x0,8mm		
<b>Anschluss (PE)</b> Terminal (PE)	: Flachsteckanschluss 6,3x0,8mm Plug type terminal 6,3x0,8mm		
<b>Bemerkungen</b> Notes	: <i>Die angegebenen technischen Daten sind typisch. Material-und fertigungsbedingt können Abweichungen auftreten.</i> Technical specifications are typical, they can due to material and product tolerances.		

**Anschlusskennzeichnung:**  
 Terminal Identification



**Abmessungen:**  
 Dimensions

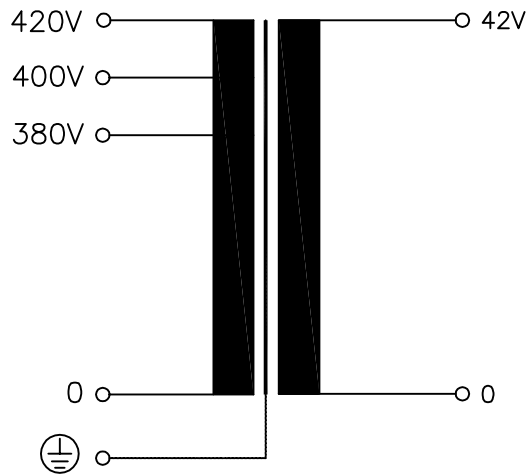
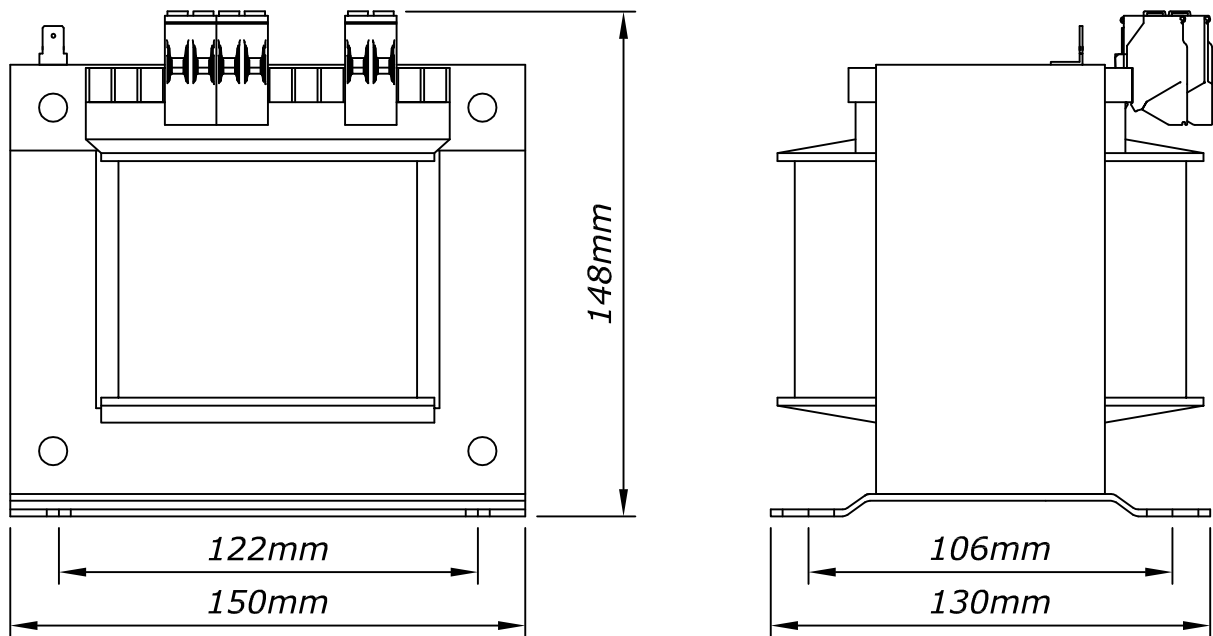

**Befestigungslöcher:** 7,0x15,0mm  
 Mounting holes: 7,0x15,0mm

**Gewicht:** ca. 10,6kg  
 Weight: approx. 10,6kg