

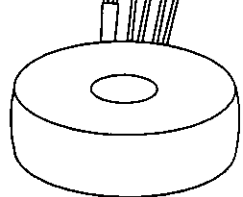



<b>Typ</b> Type	: 1~ <b>Sicherheitstransformator</b> 1~ Safety isolating transformer		
<b>Kernform</b> Core type	: <b>Ringbandkern</b> Torriodal		
<b>Bemessungsspannung, Eingang</b> Designated input voltage	: <b>230V</b>		
<b>Bemessungsstrom, Eingang</b> Designated input current	: <b>0,91Aac</b>		
<b>Bemessungsspannung, Ausgang</b> Designated output voltage	: <b>2x 12V</b>		
<b>Bemessungsstrom, Ausgang</b> Designated output current	: <b>8,33Aac</b>		
<b>Vorzusehende Absicherung, Ausgang</b> Recommended output fuse	:  <b>8,0AT</b>		
<b>Einschaltdauer</b> Duty cycle	: <b>100%</b>		
<b>Bemessungsleistung (bei Leistungsfaktor 1)</b> Designated output power (power factor 1)	: <b>200VA</b>		
<b>Verlustleistung</b> Power loss	: <b>ca. 17,6W (η ~ 91,5%)</b> approx.		
<b>Schaltgruppe</b> Connection mode	: <b>Iiii0</b>		
<b>Betriebsfrequenz</b> Designated frequency	: <b>50-60Hz</b>		
<b>Schutzklasse</b> Safety class	: <b>vorbereitet für Geräte der Schutzklasse II</b> prepared for class I equipment		
<b>Schutzart</b> Protection index	: <b>IP00</b>		
<b>Kühlungsart</b> Type of cooling	: <b>AN</b>		
<b>Isolierstoffklasse</b> Insulation class	: <b>B (UL class 105)</b>		
<b>Max. Umgebungstemperatur</b> Ambient temperature	: <b>40°C</b>		
<b>Vorschriften</b> Standards	: <b>EN 61558 Teil 1 mit Teil 2-6</b> EN 61558 part 1 with part 2-6		
<b>Prüfzeichen</b> Approvals	:  <b>UL 5085, CSA 22.2 (E 103521)</b>		
<b>Prüfspannung</b> HV-Test voltage	: <b>Primär-Sekundär 4,8 kV</b> Primary-Secondary <b>Sekundär-Sekundär 0,3 kV</b> Secondary-Secondary		
<b>Anschluß (Eingang)</b> Terminal (Input)	: <b>20-21cm UL/CSA-Litze Style 1015 AWG 20</b> 20-21cm UL/CSA- AWM style 1015 AWG 20		
<b>Anschluß (Ausgang)</b> Terminal (Output)	: <b>20-21cm Drahtenden mit Gewebeschauch</b> 20-21cm wire insulated with glass reinforced sleeving		
<b>Bemerkungen</b> Notes	: <b>Die angegebenen technischen Daten sind typisch. Material-und fertigungsbedingt können Abweichungen auftreten.</b> Technical specifications are typical, they can vary due to material and production tolerances.		

0	Date:	Name:	Date:	Checked:	Amendment:
	Date: 01.03.13	Date: 21.3.13		<b>Schutzvermerk nach ISO 16016 beachten</b> Observe protection clause to ISO 16016	
	Name: Lehnen	Checked: 		<b>Änderungen vorbehalten</b> Subject to change	

**Anschlußkennzeichnung:**  
Terminal Identification

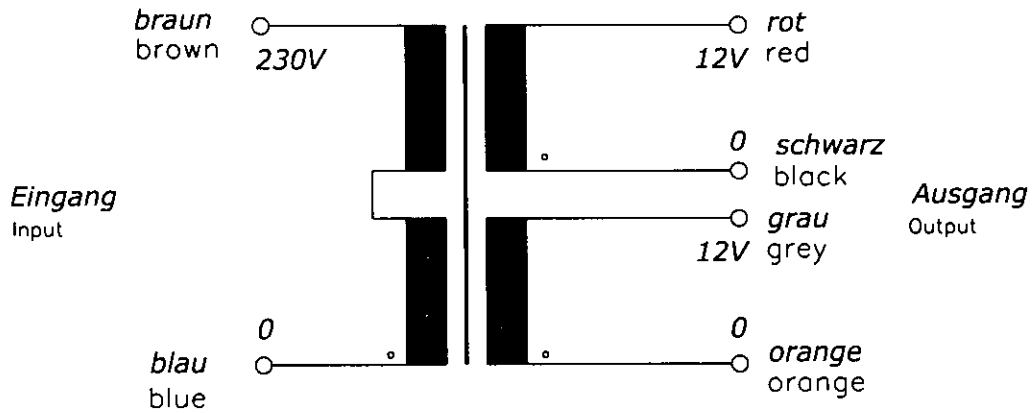

**Abmessungen:**  
Dimensions

**Außen-Ø ca. 113mm im Bereich der Ausführungen ca. 115mm**  
Outer-Ø approx. 113mm over leadouts approx. 115mm

**Höhe max. 51mm zzgl. 5mm Montageset**  
Height max. 51mm plus 5mm mounting kit

**Gewicht: ca. 2,1kg**  
Weight: approx. 2,1kg

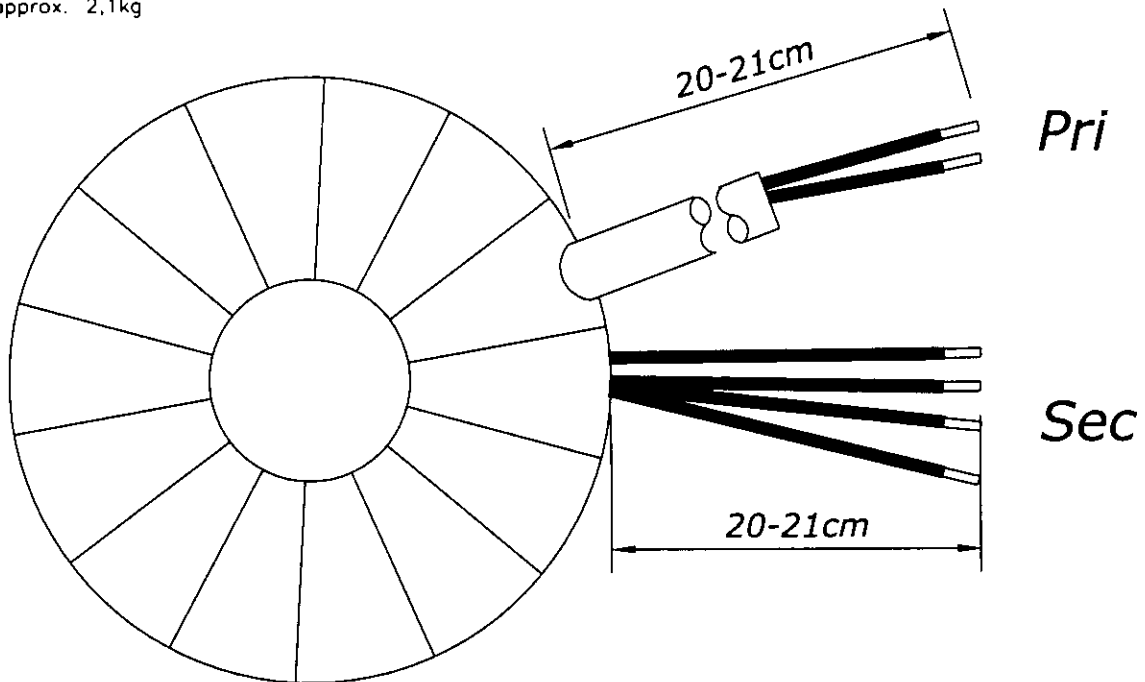

**Befestigung mit (beiliegend):**  
Mounting with (enclosed)

**1x Befestigungscheibe**  
1x Mounting plate

**2x Gummischeibe**  
2x Rubber disc

**1x Schraube M6 + Scheibe + Mutter**  
1x Screw M6 + washer + nut