

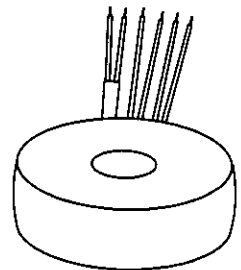



Typ Type	: 1~ Trenntransformator 1~ Isolating transformer	
Kernform Core type	: Ringbandkern Torriodal	
Bemessungsspannung, Eingang Designated input voltage	: 230V	
Bemessungsstrom, Eingang Designated input current	: 2,83Aac	
Bemessungsspannung, Ausgang Designated output voltage	: 2x 115V	
Bemessungsstrom, Ausgang Designated output current	: 2,7Aac	
Vorzusehende Absicherung, Ausgang Recommended output fuse	:  2,5AT	
Einschaltdauer Duty cycle	: 100%	
Bemessungsleistung (bei Leistungsfaktor 1) Designated output power (power factor 1)	: 625VA	
Verlustleistung Power loss	: ca. 29,3W ($\eta \sim 95,5\%$) approx.	
Schaltgruppe Connection mode	: III0	
Betriebsfrequenz Designated frequency	: 50-60Hz	
Schutzklasse Safety class	: vorbereitet für Geräte der Schutzklasse II prepared for class I equipment	
Schutzart Protection index	: IP00	
Kühlungsart Type of cooling	: AN	
Isolierstoffklasse Insulation class	: B (UL class 105)	
Max. Umgebungstemperatur Ambient temperature	: 40°C	
Vorschriften Standards	: EN 61558 Teil 1 mit Teil 2-4 EN 61558 part 1 with part 2-4	
Prüfzeichen Approvals	:  UL 5085, CSA 22.2 (E 103521)	
Prüfspannung HV-Test voltage	: Primär-Sekundär 4,8 kV Primary-Secondary Sekundär-Sekundär 0,6 kV Secondary-Secondary	
Anschluß (Eingang) Terminal (Input)	: 20-21cm UL/CSA-Litze Style 1015 AWG 18 20-21cm UL/CSA- AWM style 1015 AWG 18	
Anschluß (Ausgang) Terminal (Output)	: 20-21cm Drahtenden mit Gewebeslauch 20-21cm wire insulated with glass reinforced sleeving	
Bemerkungen Notes	: Die angegebenen technischen Daten sind typisch. Material-und fertigungsbedingt können Abweichungen auftreten. Technical specifications are typical, they can vary due to material and production tolerances.	

0	Date:	Name:	Date:	Checked:	Amendment:
	Date: 21.02.13	Name: Lehnen	Date: 1.3.13	Checked: 	Amendment:
Schutzvermerk nach ISO 16016 beachten Observe protection clause to ISO 16016					Änderungen vorbehalten Subject to change

Anschlußkennzeichnung:
 Terminal Identification

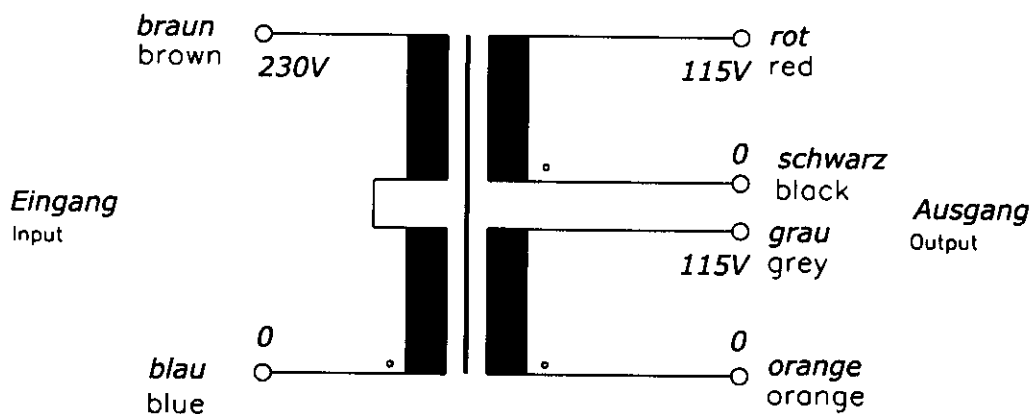

Abmessungen:
 Dimensions

Außen-Ø ca. 152mm im Bereich der Ausführungen ca. 154mm
 Outer-Ø approx. 152mm over leadouts approx. 154mm

Höhe max. 74mm zzgl. 5mm Montageset
 Height max. 74mm plus 5mm mounting kit

Gewicht: ca. 6,1kg
 Weight: approx. 6,1kg

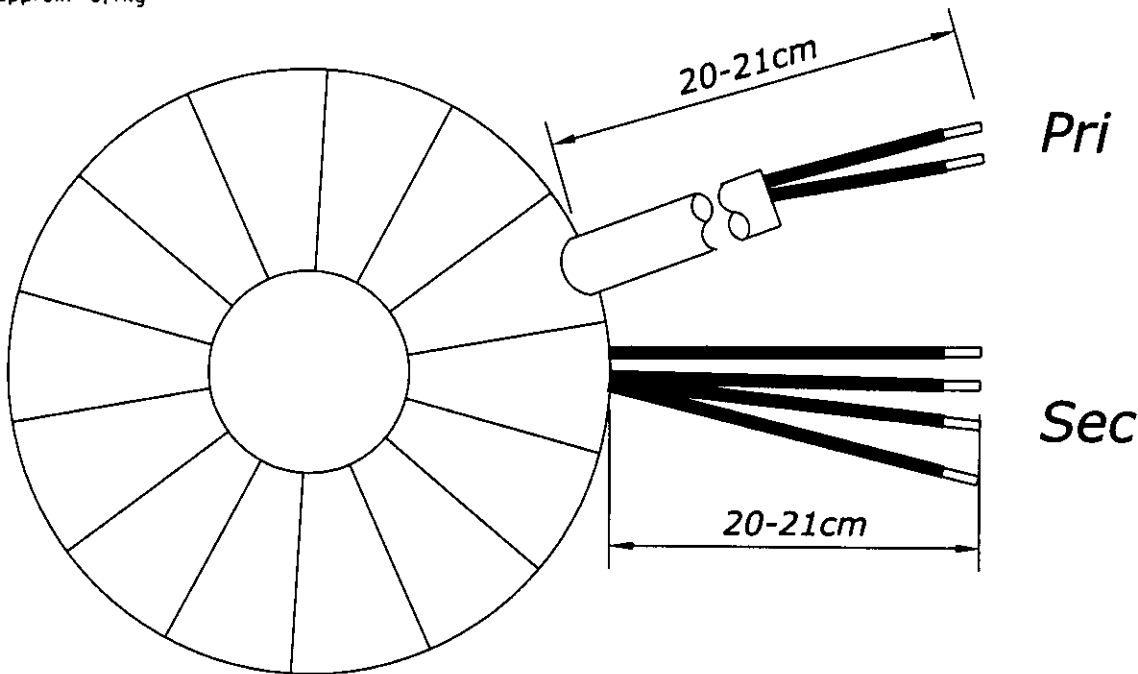

Befestigung mit (beiliegend):
 Mounting with (enclosed)

1x Befestigungscheibe
 1x Mounting plate

2x Gummischeibe
 2x Rubber disc

1x Schraube M8 + Scheibe + Mutter
 1x Screw M8 + washer + nut