

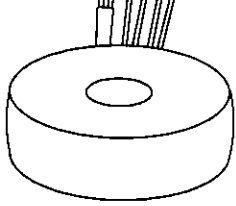



Typ Type	: 1~ Trenntransformator 1~ Isolating transformer		
Kernform Core type	: Ringbandkern Torriodal		
Bemessungsspannung, Eingang Designated input voltage	: 230V		
Bemessungsstrom, Eingang Designated input current	: 2,28Aac		
Bemessungsspannung, Ausgang Designated output voltage	: 2x 30V		
Bemessungsstrom, Ausgang Designated output current	: 8,33Aac		
Vorzusehende Absicherung, Ausgang Recommended output fuse	:  8,0AT		
Einschaltdauer Duty cycle	: 100%		
Bemessungsleistung (bei Leistungsfaktor 1) Designated output power (power factor 1)	: 500VA		
Verlustleistung Power loss	: ca. 28,1W ($\eta \sim 94,7\%$) approx.		
Schaltgruppe Connection mode	: III0		
Betriebsfrequenz Designated frequency	: 50-60Hz		
Schutzklasse Safety class	: vorbereitet für Geräte der Schutzklasse II prepared for class I equipment		
Schutzart Protection index	: IP00		
Kühlungsart Type of cooling	: AN		
Isolierstoffklasse Insulation class	: B (UL class 105)		
Max. Umgebungstemperatur Ambient temperature	: 40°C		
Vorschriften Standards	: EN 61558 Teil 1 mit Teil 2-4 EN 61558 part 1 with part 2-4		
Prüfzeichen Approvals	:  UL 5085, CSA 22.2 (E 103521)		
Prüfspannung HV-Test voltage	: Primär-Sekundär 4,8 kV Primary-Secondary Sekundär-Sekundär 0,3 kV Secondary-Secondary		
Anschluß (Eingang) Terminal (Input)	: 20-21cm UL/CSA-Litze Style 1015 AWG 18 20-21cm UL/CSA- AWM style 1015 AWG 18		
Anschluß (Ausgang) Terminal (Output)	: 20-21cm Drahtenden mit Gewebeschauch 20-21cm wire insulated with glass reinforced sleeving		
Bemerkungen Notes	: Die angegebenen technischen Daten sind typisch. Material-und fertigungsbedingt können Abweichungen auftreten. Technical specifications are typical, they can vary due to material and production tolerances.		

0	Date:	Name:	Date:	Checked:	Amendment:
	Date: 16.02.13	Date: 25.3.13			
	Name: Lehnen	Checked: 	Schutzvermerk nach ISO 16016 beachten Observe protection clause to ISO 16016		Änderungen vorbehalten Subject to change

Anschlußkennzeichnung:
Terminal Identification

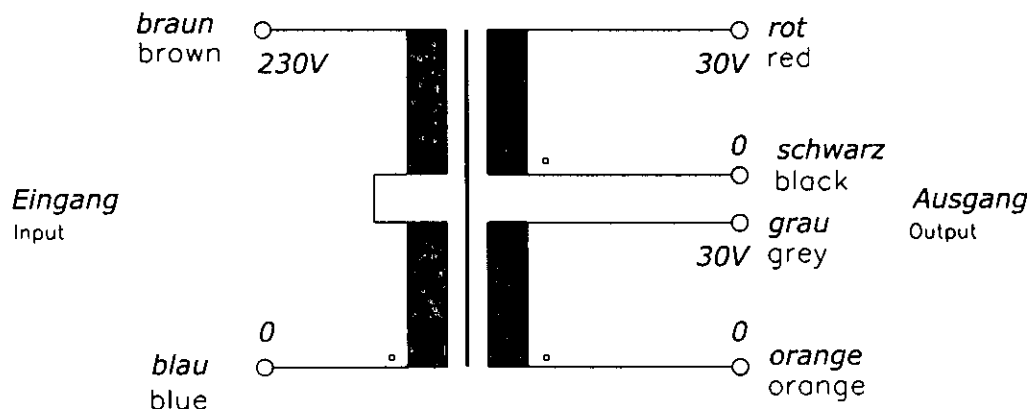

Abmessungen:
Dimensions

Außen-Ø ca. 140mm im Bereich der Ausführungen ca. 143mm
Outer-Ø approx. 140mm over leadouts approx. 143mm

Höhe max. 68mm zzgl. 5mm Montageset
Height max. 68mm plus 5mm mounting kit

Gewicht: ca. 4,8kg
Weight: approx. 4,8kg

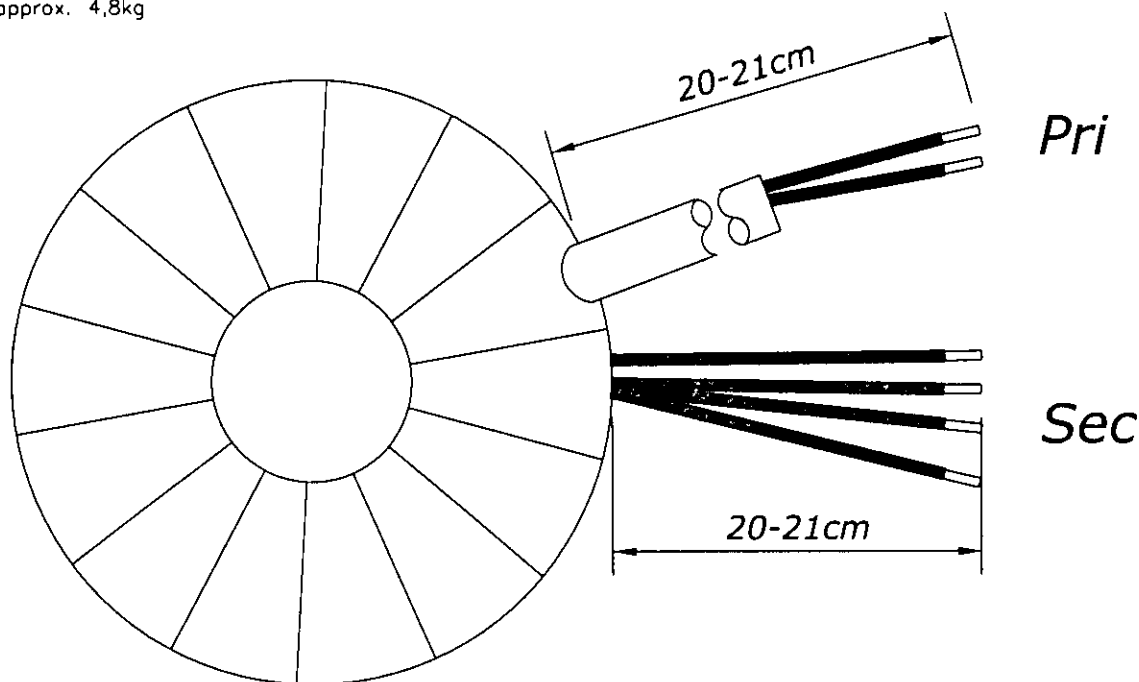

Befestigung mit (beiliegend):
Mounting with (enclosed)

1x Befestigungscheibe
1x Mounting plate

2x Gummischeibe
2x Rubber disc

1x Schraube M8 + Scheibe + Mutter
1x Screw M8 + washer + nut