

Line reactor, three-phase, 4 % (uK)DISCONTINUED MODEL
NKD 80/0,37 - no longer available

Applications

Line reactor to minimize mains pollution, to reduce the reactive-power components and charging currents in the DC link capacitor and to improve the $\cos(\phi)$.

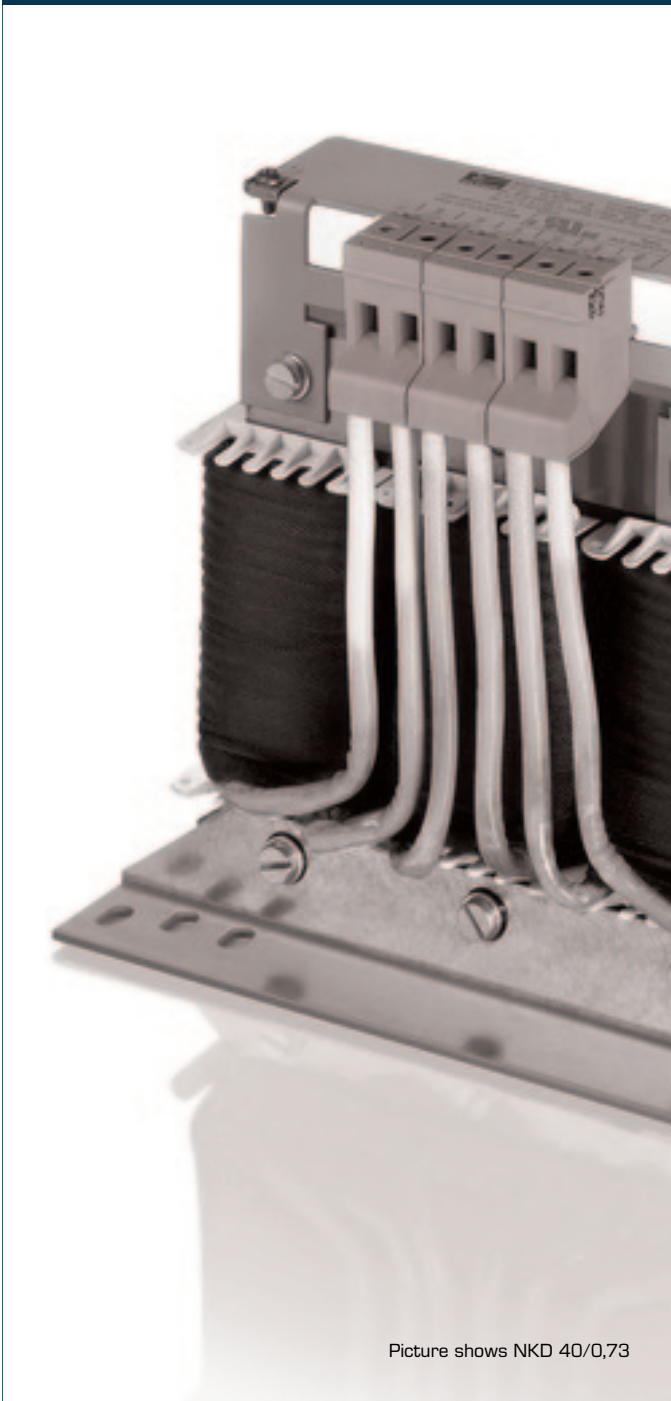

Picture shows NKD 40/0,73

Standards

Line- and commutation reactor to
DIN EN 61558-2-20, IEC 61558-2-20, UL 506, CSA 22.2

Approvals

UL 506, CSA 22.2

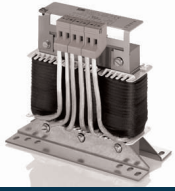

Line reactor, three-phase, 4 % (uK)DISCONTINUED MODEL NKD 80/0,37 - no longer available

Type		NKD 80/0,37 - no longer available
Electrical data	Magnetic characteristics	
	Material	
	Operating data	
	Rated voltage	3 x 400 Vac
	Rated voltage (IEC)	3 x 690 Vac
	Rated voltage (UL)	3 x 600 Vac
	Short circuit voltage uK	4 % @ 400 Vac
	Voltage drop	9.2 Vac
	Rated current	3 x 80 A
	Rated frequency	50 - 60 Hz
	Inductance	0.370 mH
	Inductance deviation	±10 %
	Approvals	
	Approvals	cURus
	Environment	
	Ambient temperature	-10 °C to +40 °C
	Type of cooling	AN
	Safety and protection	
	Insulation class	IEC=F, UL=class 155
	Protection index	IP 00
Safety class (prepared)	I	
Type	Open type	
Safety class		
Test voltage	2500 Vac	
Catalogue logic		
	Not for new designs Alternative type LR3 40-4/80	
Order numbers		
Order Number	NKD 80/0,37 - no longer available	

Type		NKD 80/0,37 - no longer available
Mechanical data	Terminal and mounting	
	Terminals phase	Flat copper
	Terminals PE	for M8
	Fixing method	Fixing rail
	Fixing screws	M6
	Measures and weights	
	Weight	17.70 kg

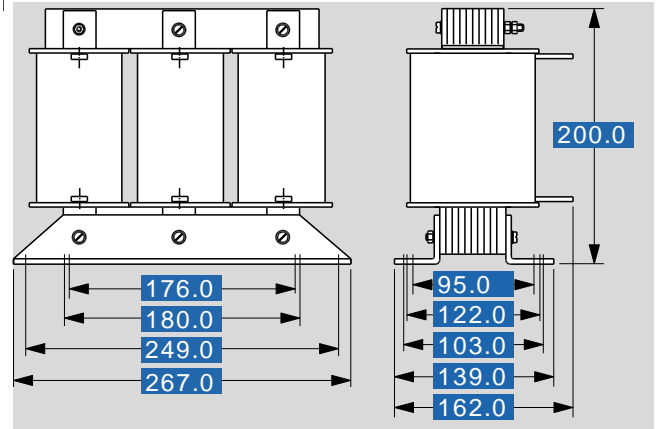

Subject to change.