

Line reactor, three-phase, 4 % (uK)DISCONTINUED MODEL
NKD 25/1,17 - no longer available

Applications

Line reactor to minimize mains pollution, to reduce the reactive-power components and charging currents in the DC link capacitor and to improve the $\cos(\phi)$.

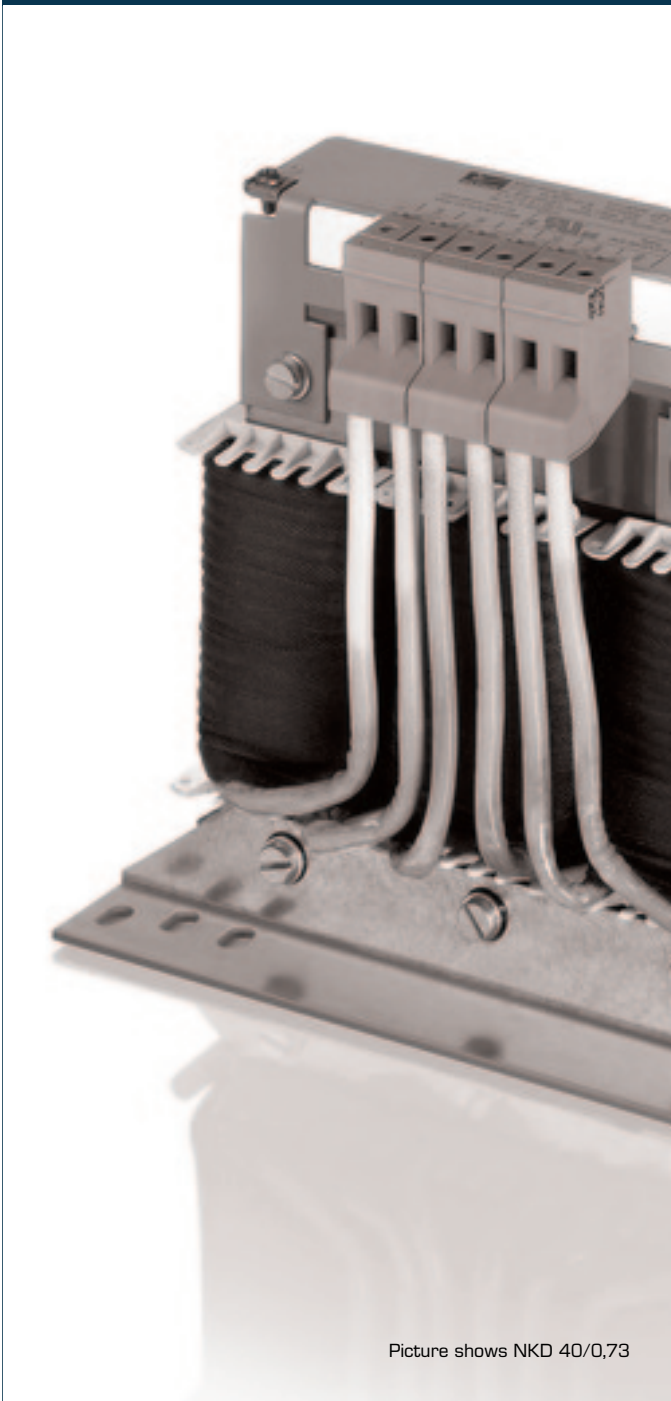

Picture shows NKD 40/0,73

Standards

Line- and commutation reactor to
DIN EN 61558-2-20, IEC 61558-2-20, UL 506, CSA 22.2

Approvals

UL 506, CSA 22.2

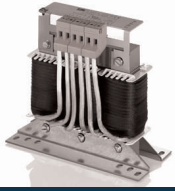

Line reactor, three-phase, 4 % (uK)DISCONTINUED MODEL NKD 25/1,17 - no longer available

Type		NKD 25/1,17 - no longer available
Electrical data	Magnetic characteristics	
	Material	
	Operating data	
	Rated voltage	3 x 400 Vac
	Rated voltage (IEC)	3 x 690 Vac
	Rated voltage (UL)	3 x 600 Vac
	Short circuit voltage uK	4 % @ 400 Vac
	Voltage drop	9.2 Vac
	Rated current	3 x 25 A
	Rated frequency	50 - 60 Hz
	Inductance	1.170 mH
	Inductance deviation	±10 %
	Approvals	
	Approvals	cURus
	Environment	
	Ambient temperature	-10 °C to +40 °C
	Type of cooling	AN
	Safety and protection	
	Insulation class	IEC=F, UL=class 155
	Protection index	IP 00
Safety class (prepared)	I	
Type	Open type	
Safety class		
Test voltage	2500 Vac	
Catalogue logic		
	Not for new designs Alternative type LR3 40-4/25	
Order numbers		
Order Number	NKD 25/1,17 - no longer available	

Type		NKD 25/1,17 - no longer available
Mechanical data	Terminal and mounting	
	Terminals phase	Screw clamp, 10 mm ²
	Terminals PE	for M4
	Fixing method	Fixing rail
	Fixing screws	M4
	Measures and weights	
	Weight	3.80 kg

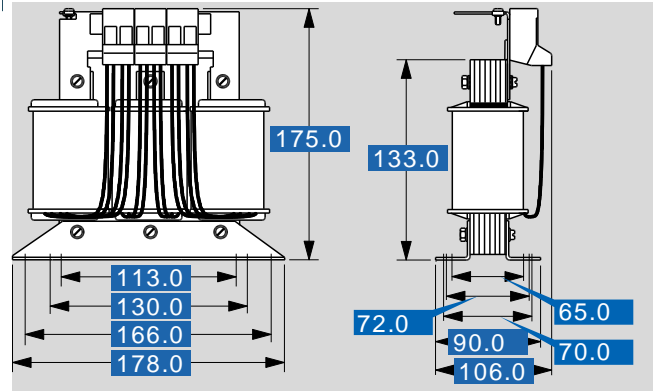

Subject to change.