

Mains transformer FLN 4/21* - no longer available



Picture shows FLN 30/12

Applications

As a mains transformer for adjustment of the voltage and simple electrical isolation.

As an isolating transformer for the safe electrical isolation of the input and output sides. The transformer may be used to set up protective separation as a protective measure.

As a safety isolating transformer for the safe electrical isolation of the input and output sides. The transformer is suitable for creating SELV and PELV circuits because of the limit on the output voltage.

Sample application



Standards

Mains transformer
to: VDE 0570 Teil 2-1, DIN EN 61558-2-1, EN 61558-2-1, IEC 61558-2-1, UL 5085-1/-2, CSA 22.2 No.66

Approvals



ENEC 10 (VDE), UL 5085-1/-2, CSA 22.2 No.66



Mains transformer

FLN 4/21* - no longer available

Type		FLN 4/21* - no longer available
Electrical data	Input	
	Rated input voltage	2 x 115 Vac
	Rated frequency	50 - 60 Hz
	Output	
	Rated output voltage	2 x 21 Vac
	Rated Power	4.0 VA
	No-load voltage (app. x factor)	1.53
	No-load loss (typ.)	0.85 W
	Efficiency	58.0 %
	Standards	
	Classification	Mains transformer
	Approvals	
	Approvals	cURus, ENEC 10 (VDE)
	Environment	
	Ambient temperature max.	70 °C
Safety and protection		
Type	Encapsulated	
Insulation class	B	
Protection index	IP 00	
Safety class (prepared)	II	
Short circuit strength	non-short-circuit proof	
Catalogue logic		
Order numbers		
Order Number	FLN 4/21* - no longer available	

Type		FLN 4/21* - no longer available
Terminal and mounting		
Terminals		Pins for PCB
Measures and weights		
Core type		UI 30/7,5
Weight		0.15 kg

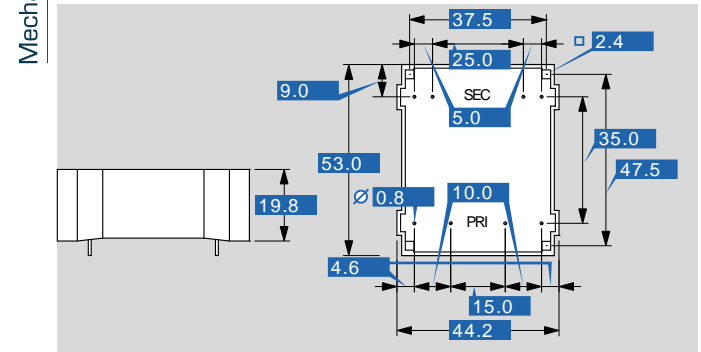

Subject to change.