

Isolating transformer ETTK 160



Picture shows ETTK 630

Advantages

Safe galvanic isolation
Integrated short-circuit and overload protection
Very good moisture protection and low noise thanks to resin encapsulation
High degree of protection
Carry handle, shockproof socket for portable application

Applications

Isolating transformer for the safe electrical isolation of the input and output sides. The transformer may be used to set up protective separation as a protective measure in accordance with VDE 0100.

Sample application

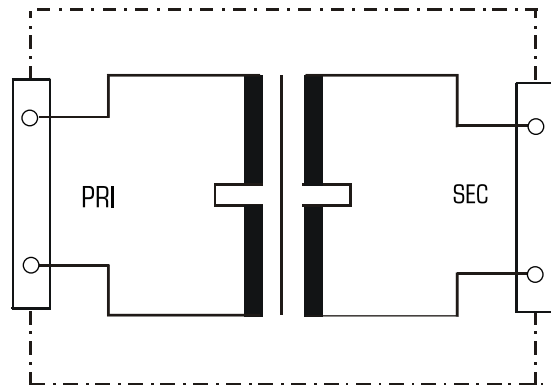

Standards

Isolating transformer
to: VDE 0570 Part 2-4, DIN EN 61558-2-4, EN 61558-2-4, IEC 61558-2-4

Approvals





Isolating transformer ETTK 160

Type		ETTK 160
Electrical data	Input	
	Rated frequency	50 - 60 Hz
	Rated input voltage	230 Vac
	Output	
	Rated output voltage	230 Vac
	Rated Power	160 VA
	Environment	
	Ambient temperature max.	40 °C
	Safety and protection	
	Type	Resin encapsulated transformer
	Insulation class	A
	Protection index	IP 67
	Safety class	II
	Short circuit strength	short-circuit proof
	Test voltage	4,000 Vac, 50 Hz
Order numbers		
Order Number	ETTK 160	

Type		ETTK 160
Mechanical data	Terminal and mounting	
	Terminals Input	Mains connecting cable with Schuko plug
	Terminals Output	Shockproof socket
Measures and weights		
Weight		5.80 kg

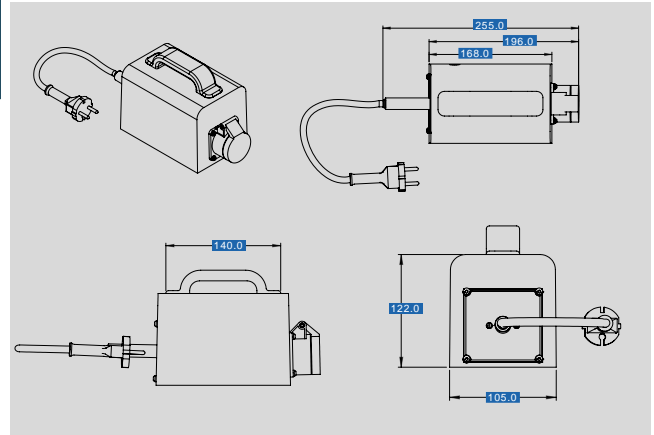

Subject to change.