

Separating transformer CT-025-048-X1-0

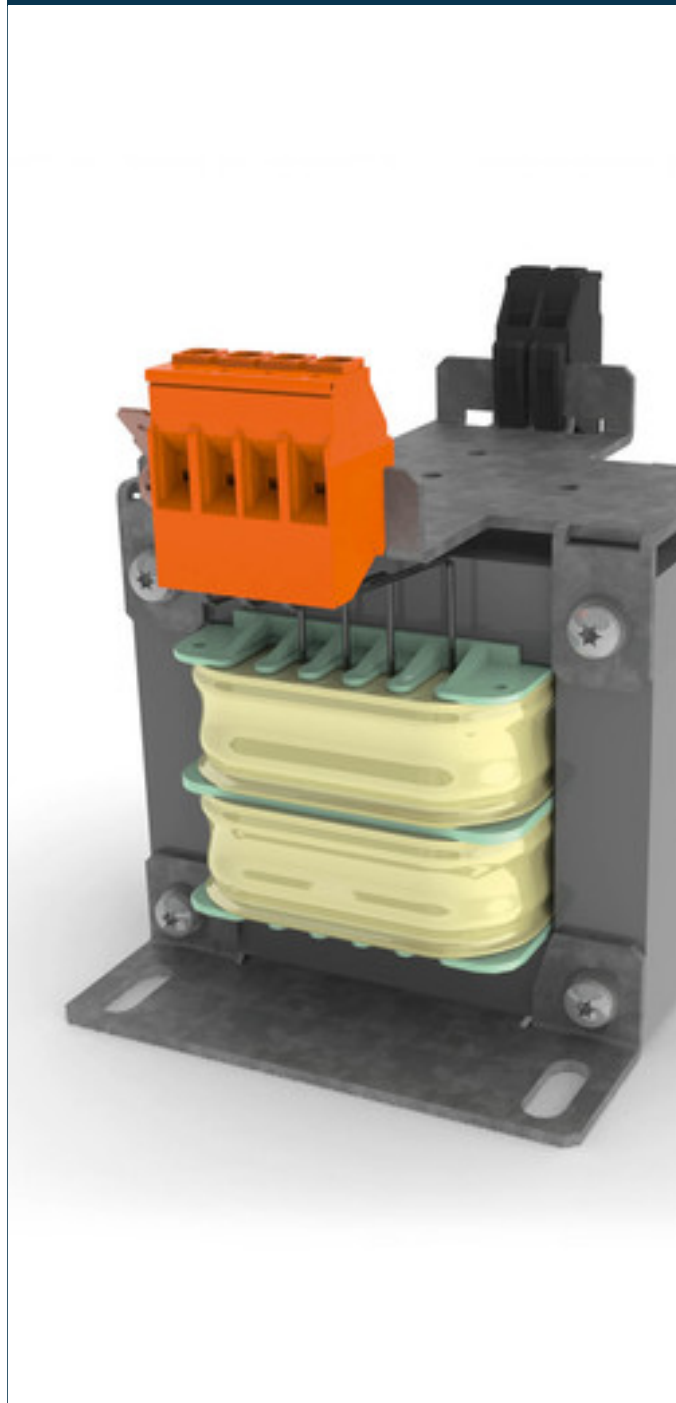

Advantages

Fused versions available

Versions with DIN rail for additional components available

Contact protected screw connection terminals

Jumpers included for primary voltage selection

Very good corrosion protection and low noise thanks to BLOCK IMPEX vacuum impregnation

Up to 2,500 VA

Applications

As a separating transformer for adjustment of the voltage and simple electrical isolation.

Sample application

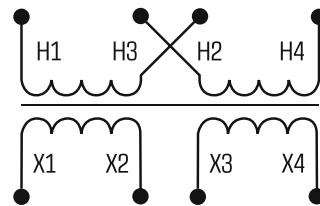

Standards

Separating transformer
to: EN 61558 part 1 with part 2-1, UL 5085-1/-2;2:2, CSA 22.2 No. 66

Approvals



UL 5085-1/-2, CSA 22.2 No.66, EAC



Separating transformer CT-025-048-X1-0

Type		CT-025-048-X1-0
Electrical data	Input	
	Rated input voltage	2 x 240 Vac
	Rated input current	0,58 Aac
	Output	
	Rated output voltage	120 Vac + 24 Vac
	Rated Power	187 VA + 63 VA
	Approvals	
	Approvals	cURus, EAC
	Environment	
	Ambient temperature	max. 40 °C
Type of cooling	self-cooling	
Safety and protection		
Type	Open type	
Insulation class	B, class 130	
Protection index	IP 00	
Safety class (prepared)	I	
Short circuit strength	non-short-circuit proof	
Order numbers		
Order Number		CT-025-048-X1-0

Type		CT-025-048-X1-0
Mechanical data	Terminal and mounting	
	Fixing method	Base plate
	Terminals Input	Screw clamp, 4 mm ²
	Fixing screws	M4
	Terminals Output	Screw clamp, 4 mm ²
Terminals PE	Tab connector, 6.3 x 0.8 mm	
Measures and weights		
Weight		3.50 kg

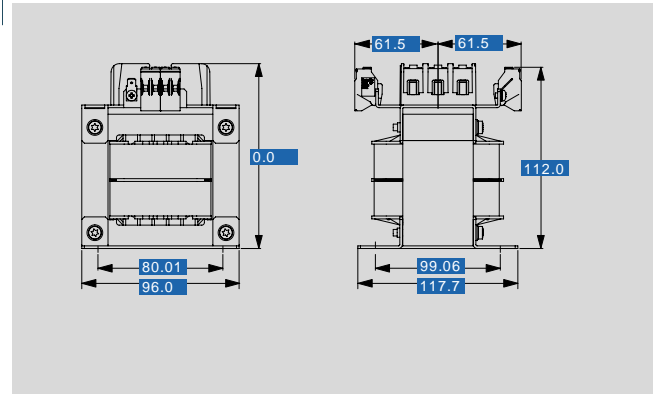

Subject to change.